

MODULE CONFIGURATIONS

Viking Part Number	Capacity	Module Configuration	Device Configuration	Device Package	Module Ranks	Performance	CAS Latency
VR7JA287258FBZ	1GB	128Mx72	128Mx8	FBGA	1	PC3-6400	CL6 (6-6-6)
VR7JA287258FBA	1GB	128Mx72	128Mx8	FBGA	1	PC3-8500	CL7 (7-7-7)
VR7JA287258FBD	1GB	128Mx72	128Mx8	FBGA	1	PC3-10600	CL9 (9-9-9)
VR7JA287258FBx	1GB	128Mx72	128Mx8	FBGA	1	PC3-12800	CL10 (10-10-10)
VR7JA287258FBF	1GB	128Mx72	128Mx8	FBGA	1	PC3-12800	CL11 (11-11-11)
VR7JA567258GBZ	2GB	256Mx72	256Mx8	FBGA	1	PC3-6400	CL6 (6-6-6)
VR7JA567258GBA	2GB	256Mx72	256Mx8	FBGA	1	PC3-8500	CL7 (7-7-7)
VR7JA567258GBD	2GB	256Mx72	256Mx8	FBGA	1	PC3-10600	CL9 (9-9-9)
VR7JA567258GBx	2GB	256Mx72	256Mx8	FBGA	1	PC3-12800	CL10 (10-10-10)
VR7JA567258GBF	2GB	256Mx72	256Mx8	FBGA	1	PC3-12800	CL11 (11-11-11)
VR7JA567258FBZ	2GB	256Mx72	128Mx8	FBGA	2	PC3-6400	CL6 (6-6-6)
VR7JA567258FBA	2GB	256Mx72	128Mx8	FBGA	2	PC3-8500	CL7 (7-7-7)
VR7JA567258FBD	2GB	256Mx72	128Mx8	FBGA	2	PC3-10600	CL9 (9-9-9)
VR7JA567258FBx	2GB	256Mx72	128Mx8	FBGA	2	PC3-12800	CL10 (10-10-10)
VR7JA567258FBF	2GB	256Mx72	128Mx8	FBGA	2	PC3-12800	CL11 (11-11-11)
VR7JA127258GBZ	4GB	512Mx72	256Mx8	FBGA	2	PC3-6400	CL6 (6-6-6)
VR7JA127258GBA	4GB	512Mx72	256Mx8	FBGA	2	PC3-8500	CL7 (7-7-7)
VR7JA127258GBD	4GB	512Mx72	256Mx8	FBGA	2	PC3-10600	CL9 (9-9-9)
VR7JA127258GBx	4GB	512Mx72	256Mx8	FBGA	2	PC3-12800	CL10 (10-10-10)
VR7JA127258GBF	4GB	512Mx72	256Mx8	FBGA	2	PC3-12800	CL11 (11-11-11)
VR7JA127258HBZ	4GB	512Mx72	512Mx8	FBGA	1	PC3-6400	CL6 (6-6-6)
VR7JA127258HBA	4GB	512Mx72	512Mx8	FBGA	1	PC3-8500	CL7 (7-7-7)
VR7JA127258HBD	4GB	512Mx72	512Mx8	FBGA	1	PC3-10600	CL9 (9-9-9)
VR7JA127258HBx	4GB	512Mx72	512Mx8	FBGA	1	PC3-12800	CL10 (10-10-10)
VR7JA127258HBF	4GB	512Mx72	512Mx8	FBGA	1	PC3-12800	CL11 (11-11-11)
VR7JA1G7258HBZ	8GB	1Gx72	512Mx8	FBGA	2	PC3-6400	CL6 (6-6-6)
VR7JA1G7258HBA	8GB	1Gx72	512Mx8	FBGA	2	PC3-8500	CL7 (7-7-7)
VR7JA1G7258HBD	8GB	1Gx72	512Mx8	FBGA	2	PC3-10600	CL9 (9-9-9)
VR7JA1G7258HBx	8GB	1Gx72	512Mx8	FBGA	2	PC3-12800	CL10 (10-10-10)
VR7JA1G7258HBF	8GB	1Gx72	512Mx8	FBGA	2	PC3-12800	CL11 (11-11-11)
VR7JA2G7258JBZ	16GB	2Gx72	1Gx8(18)	FBGA	2	PC3-6400	CL6 (6-6-6)
VR7JA2G7258JBA	16GB	2Gx72	1Gx8(18)	FBGA	2	PC3-8500	CL7 (7-7-7)
VR7JA2G7258JBD	16GB	2Gx72	1Gx8(18)	FBGA	2	PC3-10600	CL9 (9-9-9)
VR7JA2G7258JBF	16GB	2Gx72	1Gx8(18)	FBGA	2	PC3-12800	CL11 (11-11-11)
VR7JA2G7258JBG	16GB	2Gx72	1Gx8(18)	FBGA	2	PC3-14900	CL13 (13-13-13)

Notes: For part numbers containing an x, contact Viking for the complete PN

Viking Technology ♦ 2950 Red Hill Ave ♦ Costa Mesa, CA 92626

Office: 714.913.2200 Fax: 714.913.2202 ♦ Website: <http://www.vikingtechnology.com>

This Data Sheet is subject to change without notice.

Doc. # PS7JAxx7258xxx-LF ■ Revision D ■



Features

- JEDEC standard Power Supply
 - VDD = VDDQ = 1.5V ±0.075V
 - VDDSPD = +3.0V to +3.6V
- 244pin Mini registered Dual-In-Line Memory Module with parity bit for address and control bus.
- 8 Internal Banks.
- Programmable CAS Latency: 6, 7, 8, 9, 10, 11
- Programmable CAS Write Latency (CWL).
- Programmable Additive Latency (Posted CAS).
- Fixed burst chop (BC) of 4 and burst length (BL) of 8 via the mode register set (MRS)
- Selectable BC4 or BL8 on-the-fly (OTF)
- On-Die-Termination (ODT) and Dynamic ODT for improved signal integrity.
- Refresh. Self Refresh and Power Down Modes.
- ZQ Calibration for output driver and ODT.
- System Level Timing Calibration Support via Write Leveling and Multi Purpose Register (MPR) Read Pattern.
- Serial Presence Detect with EEPROM.
- On-DIMM Thermal Sensor.
- Asynchronous Reset.
- Mini RDIMM dimensions: 82 mm x 30 mm.
- RoHS Compliant* (see last page)

Nomenclature

Module Standard	SDRAM Standard	Clock
PC3-6400	DDR3-800	400MHz
PC3 -8500	DDR3-1066	533MHz
PC3-10600	DDR3-1333	667MHz
PC3-12800	DDR3-1600	800MHz

Viking Technology ♦ 2950 Red Hill Ave ♦ Costa Mesa, CA 92626

Office: 714.913.2200 Fax: 714.913.2202 ♦ Website: <http://www.vikingtechnology.com>

This Data Sheet is subject to change without notice.
Doc. # PS7JAxx7258xxx-LF ■ Revision D ■



PIN CONFIGURATIONS

Pin	Front Side	Pin	Back Side	Pin	Front Side	Pin	Back Side	Pin	Front Side	Pin	Back Side	Pin	Front Side	Pin	Back Side
1	VTT, NC	123	VTT, NC	32	DQ25	154	VSS	63	VDD	185	VDD	92	DQ40	214	DQ45
2	VREFDQ	124	VSS	33	VSS	155	DM3,DQS12, TDQS12	64	NC, CK1	186	CK0	93	DQ41	215	VSS
3	VSS	125	DQ4	34	DQS3#	156	NC,DQS12#, TDQS12#	65	NC, CK1#	187	CK0#	94	VSS	216	DM5,DQS14, TDQS14
4	DQ0	126	DQ5	35	DQS3	157	VSS	KEY				95	DQS5#	217	NC, DQS14#, TDQS14#
5	DQ1	127	VSS	36	VSS	158	DQ30					96	DQS5	218	VSS
6	VSS	128	DM0,DQS9, TDQS9	37	DQ26	159	DQ31	66	VDD	188	VDD	97	VSS	219	DQ46
7	DQS0#	129	NC,DQS9#, TDQS9#	38	DQ27	160	VSS	67	VREFCA	189	VDD	98	DQ42	220	DQ47
8	DQS0	130	VSS	39	VSS	161	CB4	68	VDD	190	EVENT#	99	DQ43	221	VSS
9	VSS	131	DQ6	40	CB0	162	CB5	69	Par_In, NC	191	A0	100	VSS	222	DQ52
10	DQ2	132	DQ7	41	CB1	163	VSS	70	VDD	192	VDD	101	DQ48	223	DQ53
11	DQ3	133	VSS	42	VSS	164	DM8,DQS17, TDQS17	71	A10 / AP	193	BA1	102	DQ49	224	VSS
12	VSS	134	DQ12	43	DQS8#	165	NC,DQS17#, TDQS17#	72	BA0	194	VDD	103	VSS	225	DM6,DQS15, TDQS15
13	DQ8	135	DQ13	44	DQS8	166	VSS	73	VDD	195	RAS#	104	DQS6#	226	NC,DQS15#, TDQS15#
14	DQ9	136	VSS	45	VSS	167	CB6	74	WE#	196	S0#	105	DQS6	227	VSS
15	VSS	137	DM1,DQS10, TDQS10	46	CB2	168	CB7	75	CAS#	197	VDD	106	VSS	228	DQ54
16	DQS1#	138	NC,DQS10#, TDQS10#	47	CB3	169	VSS	76	VDD	198	ODT0	107	DQ50	229	DQ55
17	DQS1	139	VSS	48	VSS	170	RFU	77	S1#, NC	199	A13	108	DQ51	230	VSS
18	VSS	140	DQ14	49	RFU	171	NC(TEST)	78	ODT1, NC	200	VDD	109	VSS	231	DQ60
19	DQ10	141	DQ15	50	RESET#	172	CKE1, NC	79	VDD	201	S3#, NC	110	DQ56	232	DQ61
20	DQ11	142	VSS	51	CKE0	173	VDD	80	S2#, NC	202	RFU	111	DQ57	233	VSS
21	VSS	143	DQ20	52	VDD	174	A15, NC	81	RFU	203	VSS	112	VSS	234	DM7,DQS16, TDQS16
22	DQ16	144	DQ21	53	BA2	175	A14	82	VSS	204	DQ36	113	DQS7#	235	NC,DQS16#, TDQS16#
23	DQ17	145	VSS	54	Err_Out# NC	176	VDD	83	DQ32	205	DQ37	114	DQS7	236	VSS
24	VSS	146	DM2,DQS11, TDQS11	55	VDD	177	A12 / BC#	84	DQ33	206	VSS	115	VSS	237	DQ62
25	DQS2#	147	NC,DQS11#, TDQS11#	56	A11	178	A9	85	VSS	207	DM4,DQS13, TDQS13	116	DQ58	238	DQ63
26	DQS2	148	VSS	57	A7	179	VDD	86	DQS4#	208	NC,DQS13#, TDQS13#	117	DQ59	239	VSS
27	VSS	149	DQ22	58	VDD	180	A8	87	DQS4	209	VSS	118	VSS	240	VDDSPD
28	DQ18	150	DQ23	59	A5	181	A6	88	VSS	210	DQ38	119	SA0	241	SA1
29	DQ19	151	VSS	60	A4	182	VDD	89	DQ34	211	DQ39	120	SCL	242	SDA
30	VSS	152	DQ28	61	VDD	183	A3	90	DQ35	212	VSS	121	SA2	243	VSS
31	DQ24	153	DQ29	62	A2	184	A1	91	VSS	213	DQ44	122	VTT	244	VTT

Viking Technology ♦ 2950 Red Hill Ave ♦ Costa Mesa, CA 92626

Office: 714.913.2200 Fax: 714.913.2202 ♦ Website: <http://www.vikingtechnology.com>

This Data Sheet is subject to change without notice.
Doc. # PS7JAx7258xxx-LF ■ Revision D ■



PIN FUNCTION DESCRIPTION

SYMBOL	TYPE	POLARITY	DESCRIPTION
CK0	IN	Positive Edge	Positive line of the differential pair of system clock inputs that drives input to the on-DIMM Clock Driver.
CK0#	IN	Negative Edge	Negative line of the differential pair of system clock inputs that drives the input to the on-DIMM Clock Driver.
CKE[1:0]	IN	Active High	CKE HIGH activates, and CKE LOW deactivates internal clock signals, and device input buffers and output drivers of the SDRAMs. Taking CKE LOW provides PRECHARGE POWER-DOWN and SELF REFRESH operation (all banks idle), or ACTIVE POWER DOWN (row ACTIVE in any bank)
S[3:0]#	IN	Active Low	Enables the associated SDRAM command decoder when low and disables decoder when high. When decoder is disabled, new commands are ignored and previous operations continue. These input signals also disable all outputs (except CKE and ODT) of the register(s) on the DIMM when both inputs are high. When both S[1:0] are high, all register outputs (except CKE, ODT and Chip select) remain in the previous state. For modules supporting 4 ranks, S[3:2] operate similarly to S[1:0] for a second set of register outputs.
ODT[1:0]	IN	Active High	On-Die Termination control signals
RAS#, CAS#, WE#	IN	Active Low	When sampled at the positive rising edge of the clock, CAS#, RAS#, and WE# define the operation to be executed by the SDRAM.
VREFDQ	Supply		Reference voltage for DQ0-DQ63 and CB0-CB7.
VREFCA	Supply		Reference voltage for A0-A15, BA0-BA2, RAS#, CAS#, WE#, S0#, S1#, CKE0, CKE1, Par_In, ODT0 and ODT1.
BA[2:0]	IN	-	Selects which SDRAM bank of eight is activated. BA0 - BA2 define to which bank an Active, Read, Write or Precharge command is being applied. Bank address also determines mode register is to be accessed during an MRS cycle.
A[15:13, 12/BC, 11, 10/AP, 9:0]	IN	-	Provided the row address for Active commands and the column address and Auto Precharge bit for Read/Write commands to select one location out of the memory array in the respective bank. A10 is sampled during a Precharge command to determine whether the Precharge applies to one bank (A10 LOW) or all banks (A10 HIGH). If only one bank is to be precharged, the bank is selected by BA. A12 is also utilized for BL 4/8 identification for "BL on the fly" during CAS# command. The address inputs also provide the op-code during Mode Register Set commands.
DQ [63:0], CB [7:0]	I/O	-	Data and Check Bit Input/Output pins
VDD, VSS	Supply	-	Power and ground for the DDR SDRAM input buffers and core logic.
DM [8:0]	IN	Active High	Masks write data when high, issued concurrently with input data.
VDD, VSS	Supply		Power and ground for the DDR SDRAM input buffers and core logic.
VTT	Supply		Termination Voltage for Address/Command/Control/Clock nets.
DQS[17:0]	I/O	Positive Edge	Positive line of the differential data strobe for input and output data.
DQS [17:0]#	I/O	Negative Edge	Negative line of the differential data strobe for input and output data.
TDQS[17:9], TDQS[17:9]#	OUT		TDQS, TDQS# is applicable for X8 DRAMs only. When enabled via Mode Register A11=1 in MR1, DRAM will enable the same termination resistance function on TDQS, TDQS# that is applied to DQS, DQS#. When disabled via mode register A11=0 in MR1, DM, TDQS will provide the data mask function and TDQS# is not used. X4/X16 DRAMs must disable the TDQS function via mode register A11=0 in MR1
SA [2:0]	IN	-	These signals are tied at the system planar to either VSS or VDDSPD to configure the serial SPD EEPROM address range.
SDA	I/O	-	This bidirectional pin is used to transfer data into or out of the SPD EEPROM. A resistor must be connected from the SDA bus line to VDDSPD on the system planar to act as a pull-up.
SCL	IN	-	This signal is used to clock data into and out of the SPD EEPROM. A resistor may be connected from the SCL bus time to VDDSPD on the system planar to act as a pull-up.

Viking Technology ♦ 2950 Red Hill Ave ♦ Costa Mesa, CA 92626

Office: 714.913.2200 Fax: 714.913.2202 ♦ Website: <http://www.vikingtechnology.com>

This Data Sheet is subject to change without notice.
Doc. # PS7JAx7258xxx-LF ■ Revision D ■



PIN FUNCTION DESCRIPTION

SYMBOL	TYPE	POLARITY	DESCRIPTION
EVENT#	OUT (open drain)	Active Low	This signal indicates that a thermal event has been detected in the thermal sensing device. The system should guarantee the electrical level requirement is met for the EVENT pin on TS/SPD part.
VDDSPD	Supply	-	Serial EEPROM positive power supply wired to a separate power pin at the connector which supports from 3.0 Volt to 3.6 Volt (nominal 3.3V) operation.
RESET#	IN		The RESET pin is connected to the RST pin on the register and to the OE pin on the PLL. When low, all register outputs will be driven low and the PLL clocks to the DRAMs and register(s) will be set to low level (the PLL will remain synchronized with the input clock)
Par_In	IN		Parity bit for the Address and Control bus. ("1 ": Odd, "0 ": Even)
Err_Out#	OUT		Parity error found in the Address and Control bus
TEST			Used by memory bus analysis tools (unused (NC) on memory DIMMs)

Viking Technology ♦ 2950 Red Hill Ave ♦ Costa Mesa, CA 92626

Office: 714.913.2200 Fax: 714.913.2202 ♦ Website: <http://www.vikingtechnology.com>

This Data Sheet is subject to change without notice.

Doc. # PS7JAx7258xxx-LF ■ Revision D ■



MECHANICAL OUTLINE SINGLE RANK MODULE

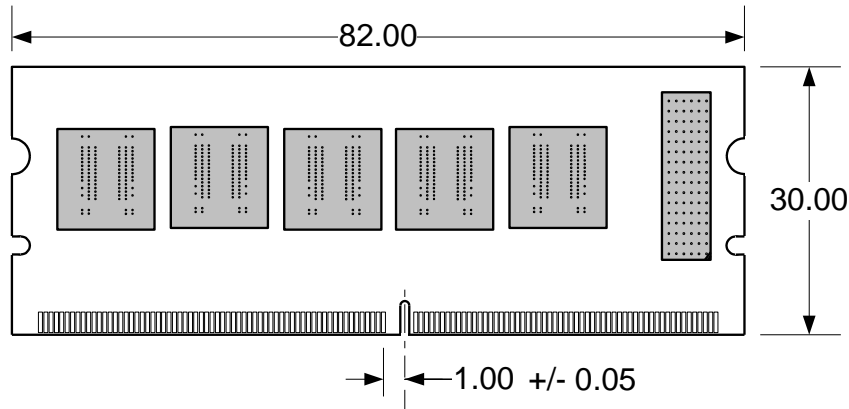

FRONT

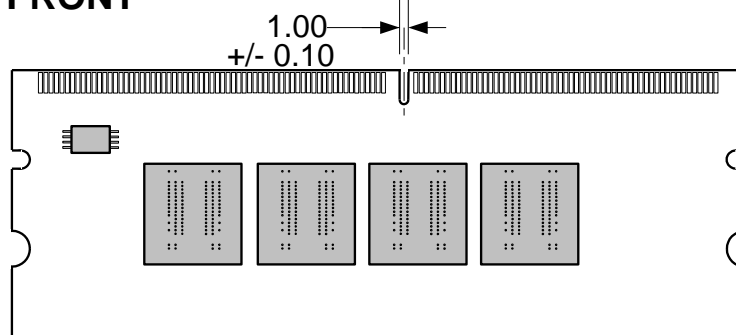

BACK

**SIDE VIEW
SINGLE RANK**

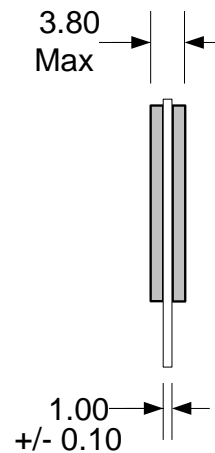

Note: All dimensions in mm. Tolerance: +/- 0.127 , unless otherwise stated.

Viking Technology ♦ 2950 Red Hill Ave ♦ Costa Mesa, CA 92626

Office: 714.913.2200 Fax: 714.913.2202 ♦ Website: <http://www.vikingtechnology.com>

This Data Sheet is subject to change without notice.
Doc. # PS7JAx7258xxx-LF ■ Revision D ■

MECHANICAL OUTLINE DUAL RANK MODULE

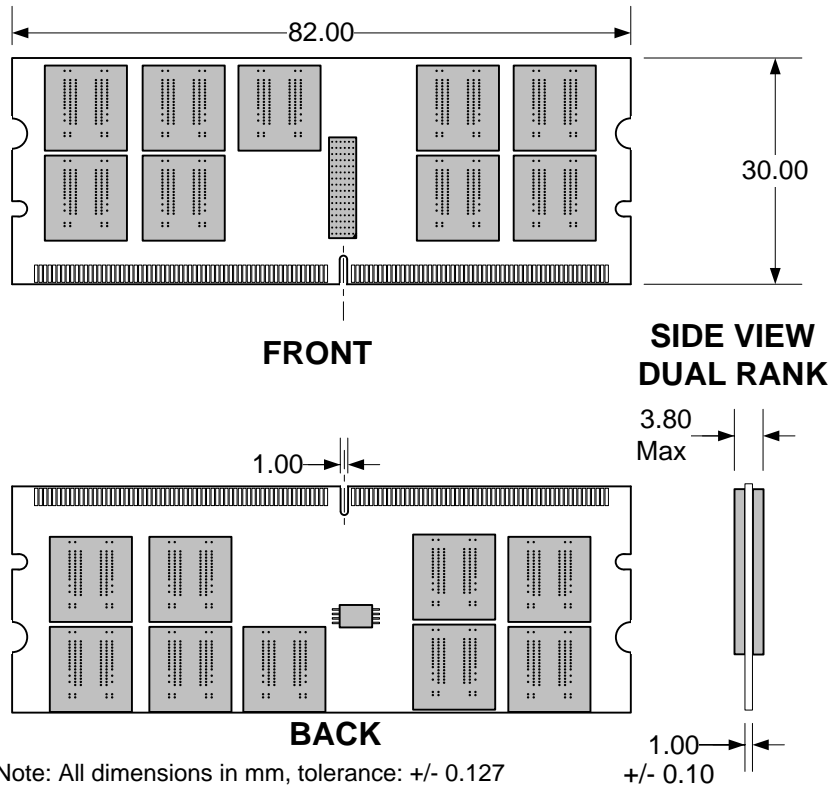

Viking Technology ♦ 2950 Red Hill Ave ♦ Costa Mesa, CA 92626

Office: 714.913.2200 Fax: 714.913.2202 ♦ Website: <http://www.vikingtechnology.com>

This Data Sheet is subject to change without notice.
Doc. # PS7JAx7258xxx-LF ■ Revision D ■

FUNCTIONAL BLOCK DIAGRAM

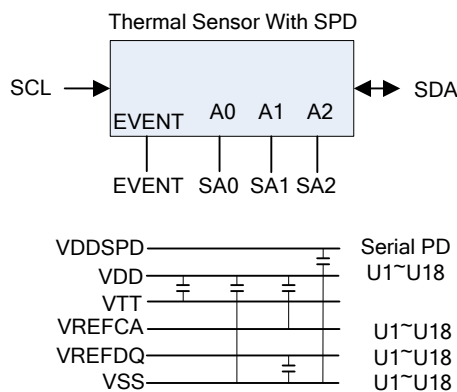
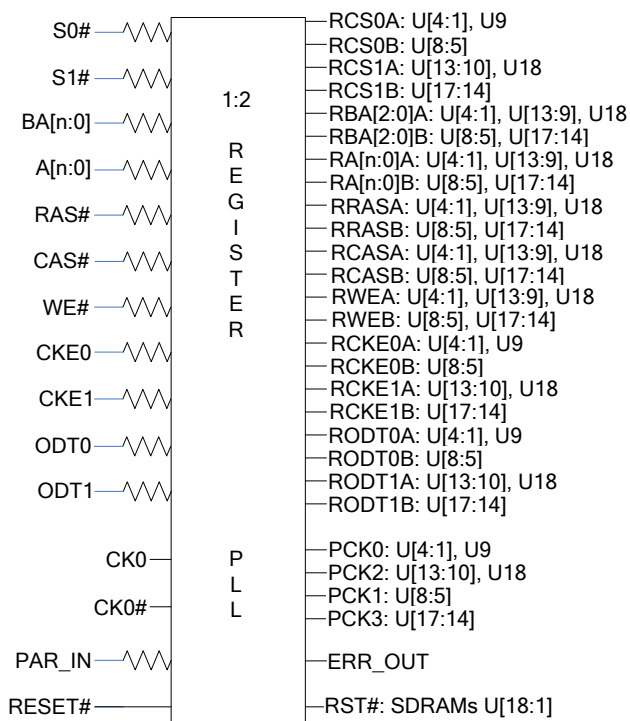

Notes:
The resistor values may vary depending on systems application

FUNCTIONAL BLOCK DIAGRAM

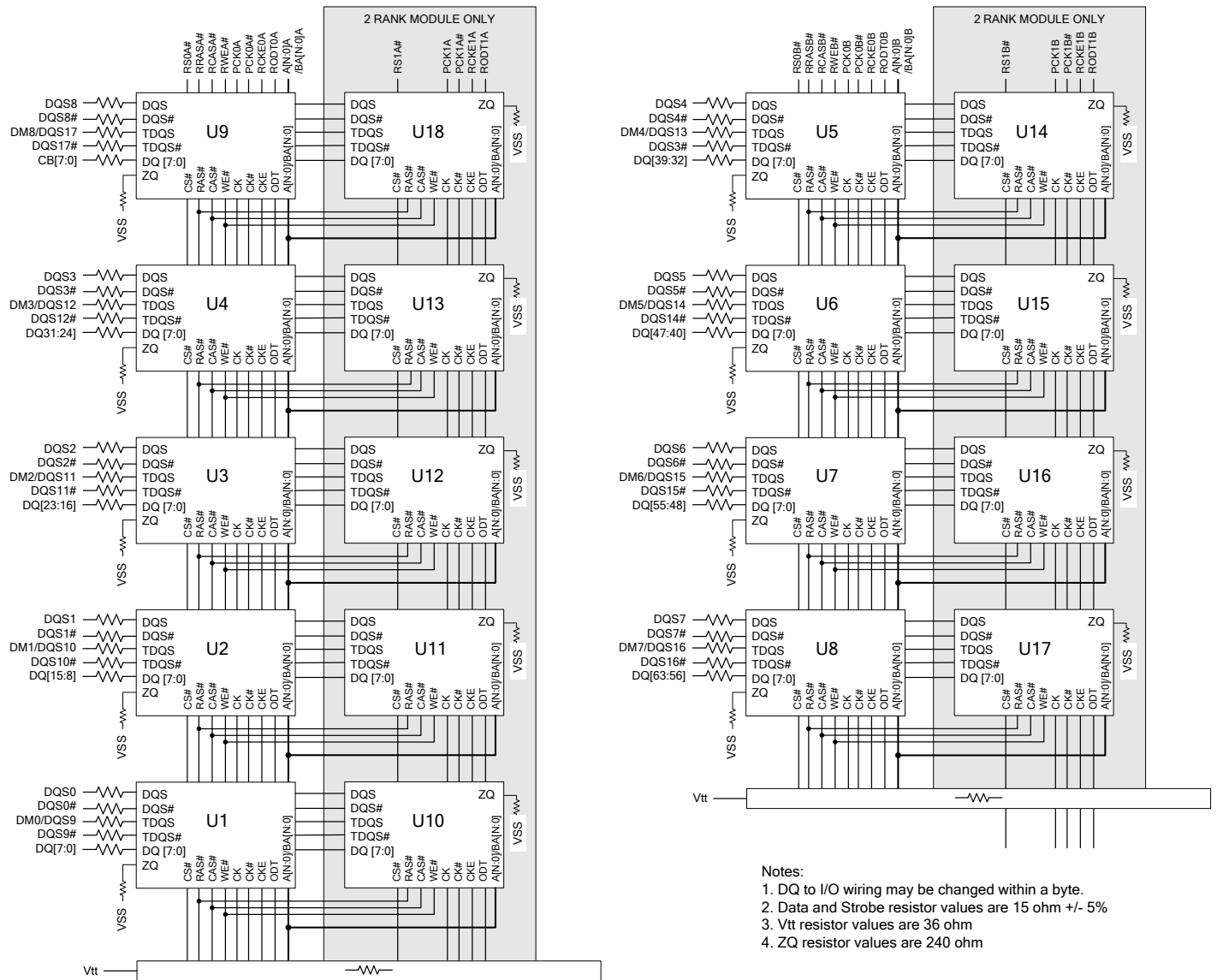

Viking Technology ♦ 2950 Red Hill Ave ♦ Costa Mesa, CA 92626

Office: 714.913.2200 Fax: 714.913.2202 ♦ Website: <http://www.vikingtechnology.com>

This Data Sheet is subject to change without notice.
Doc. # PS7JAx7258xxx-LF ■ Revision D ■



ABSOLUTE MAXIMUM RATINGS

Parameter	Symbol	Value	Unit
Voltage on any pin relative to GND	Vin, Vout	-0.4 ~ 1.975	V
Voltage on VDD supply relative to GND	VDD	-0.4 ~ 1.975	V
Voltage on VDDQ supply relative to GND	VDDQ	-0.4 ~ 1.975	V
Storage temperature	TSTG	-55 ~ +100	°C

Note: Permanent device damage may occur if 'ABSOLUTE MAXIMUM RATINGS' are exceeded. Functional operation should be restricted to recommended operating condition. Exposure to higher than recommended voltage for extended periods of time could affect device reliability.

DC OPERATING CONDITIONS AND CHARACTERISTICS (SSTL_1.5)

Recommended operating conditions (Voltages referenced to GND, Tcase = 0 to 85°C)

Parameter	Symbol	Min.	Max.	Unit	Notes
Case Temperature	Tcase	0	95	°C	5
Supply voltage	VDD	1.425	1.575	V	1, 2
Supply voltage for DQ, DQS	VDDQ	1.425	1.575	V	1, 2
Reference Voltage for DQ, DM inputs	VREFDQ(DC)	0.49 x VDD	0.51 x VDD	V	3, 4
Reference Voltage for ADD, CMD inputs	VREFCA(DC)	0.49 x VDD	0.51 x VDD	V	3, 4
Terminal Voltage	VTT	0.49 x VDD	0.51 x VDD	V	3, 4
EEPROM Supply Voltage	VDDSPD	1.7	3.6	V	
Input high voltage	VIH(AC)	VREF + 0.175	-	V	
	VIH(DC)	VREF + 0.100	VDD		
Input low voltage	VIL(AC)	-	VREF - 0.175	V	
	VIL(DC)	VSS	VREF - 0.100		
Input leakage current	Single Rank	IIL	-41	41	µA
Output leakage current	Single Rank	IOL	-10	10	µA

Note:

- VDDQ tracks with VDD. AC parameters are measured with VDD and VDDQ tied together
- Under all conditions VDDQ must be less than or equal to VDD.
- The ac peak noise on VREF may not allow VREF to deviate from VREF.DC by more than ±1% VDD (for reference: approx. ± 15 mV).
- For reference: approx. VDD/2 ± 15 mV.
- Refresh rate required to be doubled (tREFI = 3.9µs) when 85°C < TC < 95°C.

Viking Technology ♦ 2950 Red Hill Ave ♦ Costa Mesa, CA 92626

Office: 714.913.2200 Fax: 714.913.2202 ♦ Website: <http://www.vikingtechnology.com>

This Data Sheet is subject to change without notice.
Doc. # PS7JAx7258xxx-LF ■ Revision D ■



DEVICE CAPACITANCE

Parameter	Symbol	DDR3-800		DDR3-1066		DDR3-1333		Units	Notes
		Min	Max	Min	Max	Min	Max		
Input/output capacitance (DQ, DM, DQS, DQS#, TDQS,TDQS#)	CIO	1.5	3.0	1.5	2.7	1.5	2.5	pF	1,2,3
Input capacitance, CK and CK#	CCK	0.8	1.6	0.8	1.6	0.8	1.4	pF	2,3
Input capacitance delta, CK and CK#	CDCK	0	0.15	0	0.15	0	0.15	pF	2,3,4
Input/output capacitance delta DQS and DQS#	CDDQS	0	0.2	0	0.2	0	0.15	pF	2,3,5
Input capacitance, (CTRL, ADD, CMD input-only pins)	CI	0.75	1.4	0.75	1.35	0.75	1.3	pF	2,3,6
Input/output capacitance of ZQ pin	CZQ	-	3	-	3	-	3	pF	2,3,7

DEVICE CAPACITANCE (Cont.)

Parameter	Symbol	DDR3-1600		DDR3-1866		Min	Max	Units	Notes
		Min	Max	Min	Max				
Input/output capacitance (DQ, DM, DQS, DQS#, TDQS,TDQS#)	CIO	1.5	2.3	1.4	2.2			pF	1,2,3
Input capacitance, CK and CK#	CCK	0.8	1.4	0.8	1.3			pF	2,3
Input capacitance delta, CK and CK#	CDCK	0	0.15	0	0.15			pF	2,3,4
Input/output capacitance delta DQS and DQS#	CDDQS	0	0.15	0	0.15			pF	2,3,5
Input capacitance, (CTRL, ADD, CMD input-only pins)	CI	0.75	1.3	0.75	1.2			pF	2,3,6
Input/output capacitance of ZQ pin	CZQ	-	3	-	3			pF	2,3,7

Note:

1. Although the DM, TDQS and TDQS# pins have different functions, the loading matches DQ and DQS
2. This parameter is not subject to production test. It is verified by design and characterization. The capacitance is measured according to JEP147 ("PROCEDURE FOR MEASURING INPUT CAPACITANCE USING A VECTOR NETWORK ANALYZER(VNA)") with VDD, VDDQ, VSS, VSSQ applied and all other pins floating (except the pin under test, CKE, RESET# and ODT as necessary). VDD=VDDQ=1.5V, VBIAS=VDD/2 and on die termination off.
3. This parameter applies to monolithic devices only; stacked/dual-die devices are not covered here
4. Absolute value of CCK-CCK#
5. Absolute value of CIO(DQS)-CIO(DQS#)
6. CI applies to ODT, CS#, CKE, A0-A15, BA0-BA2, RAS#, CAS#, WE#.
7. Maximum external load capacitance on ZQ pin: 5 pF.

Viking Technology ♦ 2950 Red Hill Ave ♦ Costa Mesa, CA 92626

Office: 714.913.2200 Fax: 714.913.2202 ♦ Website: <http://www.vikingtechnology.com>

This Data Sheet is subject to change without notice.
Doc. # PS7JAx7258xxx-LF ■ Revision D ■



IDD CURRENT

DC CHARACTERISTICS DEFINITIONS (Recommended operating conditions unless otherwise noted, Tcase = 0 to 85 °C)

Symbol	Conditions	Units	Notes
IDD0	Operating one bank active-precharge current; tCK = tCK(IDD), tRC = tRC(IDD), tRAS = tRASmin(IDD); CKE is HIGH, CS is HIGH between valid commands; Address bus inputs are SWITCHING; Data bus inputs are SWITCHING	mA	1, 2
IDD1	Operating one bank active-read-precharge current; IOUT = 0mA; BL = 8, CL = CL(IDD), AL = 0; tCK = tCK(IDD), tRC = tRC(IDD), tRAS = tRASmin(IDD), tRCD = tRCD(IDD); CKE is HIGH, CS is HIGH between valid commands; Address bus inputs are SWITCHING; Data pattern is same as IDD4W	mA	1, 2
IDD2P-S	Precharge power-down current (slow exit); All banks idle; tCK = tCK(IDD); CKE is LOW; Other control and address bus inputs are STABLE; Data bus inputs are FLOATING	mA	1, 3
IDD2P-F	Precharge power-down current (fast exit); All banks idle; tCK = tCK(IDD); CKE is LOW; Other control and address bus inputs are STABLE; Data bus inputs are FLOATING	mA	1, 3
IDD2Q	Precharge quiet standby current; All banks idle; tCK = tCK(IDD); CKE is HIGH, CS is HIGH; Other control and address bus inputs are STABLE; Data bus inputs are FLOATING	mA	1, 3
IDD2N	Precharge standby current; All banks idle; tCK = tCK(IDD); CKE is HIGH, CS is HIGH; Other control and address bus inputs are SWITCHING; Data bus inputs are SWITCHING	mA	1, 3
IDD3P	Active power-down current; All banks open; tCK = tCK(IDD); CKE is LOW; Other control and address bus inputs are STABLE; Data bus inputs are FLOATING	mA	1, 3
IDD3N	Active standby current; All banks open; tCK = tCK(IDD), tRAS = tRASmax(IDD), tRP = tRP(IDD); CKE is HIGH, CS is HIGH between valid commands; Other control and address bus inputs are SWITCHING; Data bus inputs are SWITCHING	mA	1, 3
IDD4W	Operating burst write current; All banks open, Continuous burst writes; BL = 8, CL = CL(IDD), AL = 0; tCK = tCK(IDD), tRAS = tRASmax(IDD), tRP = tRP(IDD); CKE is HIGH, CS is HIGH between valid commands; Address bus inputs are SWITCHING; Data bus inputs are SWITCHING	mA	1, 2
IDD4R	Operating burst read current; All banks open, Continuous burst reads, IOUT = 0mA; BL = 8, CL = CL(IDD), AL = 0; tCK = tCK(IDD), tRAS = tRAS-max(IDD), tRP = tRP(IDD); CKE is HIGH, CS is HIGH between valid commands; Address bus inputs are SWITCHING; Data pattern is same as IDD4W	mA	1, 2
IDD5B	Burst refresh current; tCK = tCK(IDD); Refresh command at every tRFC(IDD) interval; CKE is HIGH, CS is HIGH between valid commands; Other control and address bus inputs are SWITCHING; Data bus inputs are SWITCHING	mA	1, 3
IDD6	Self refresh current; CK and CK at 0V; CKE ≤ 0.2V; Other control and address bus inputs are FLOATING; Data bus inputs are FLOATING	mA	1, 3
IDD6ET	Extended Temperature Range Self-Refresh Current; CK and CK at 0V; CKE ≤ 0.2V; Other control and address inputs are FLOATING; Data Bus inputs are FLOATING, PASR disabled, Applicable for MR2 setting A6=0 and A7=1	mA	1, 3
IDD7	Operating bank interleave read current; All bank interleaving reads, IOUT = 0mA; BL = 8, CL = CL(IDD), AL = tRCD(IDD)-1*tCK(IDD); tCK = tCK(IDD), tRC = tRC(IDD), tRRD = tRRD(IDD), tRCD = 1*tCK(IDD); CKE is HIGH, CS is HIGH between valid commands; Address bus inputs are STABLE during DESELECTs; Data pattern is same as IDD4R;	mA	1, 2

Notes:

- 1) Calculated values are from component data.
- 2) One module rank in the active IDD; the other rank in IDD2P-S (slow exit)
- 3) All ranks in this IDD condition.

Viking Technology ♦ 2950 Red Hill Ave ♦ Costa Mesa, CA 92626

Office: 714.913.2200 Fax: 714.913.2202 ♦ Website: <http://www.vikingtechnology.com>

This Data Sheet is subject to change without notice.

Doc. # PS7JAx7258xxx-LF ■ Revision D ■



DC CHARACTERISTICS CURRENTS SINGLE RANK 1Gbit

Symbol	DDR3-800	DDR3-1066	DDR3-1333	DDR3-1600	Unit
IDD0	720	828	900	954	mA
IDD1	900	1035	1125	1188	mA
IDD2P-S	72	72	72	75	mA
IDD2P-F	234	252	270	281	mA
IDD2Q	495	585	675	694	mA
IDD2N	495	585	675	694	mA
IDD3P	270	360	405	419	mA
IDD3N	585	675	765	777	mA
IDD4R	1260	1530	1890	2086	mA
IDD4W	1440	1800	2070	2314	mA
IDD5B	1710	1800	1890	1916	mA
IDD6	90	90	90	90	mA
IDD6ET	108	108	108	108	mA
IDD7	1890	2250	2700	2768	mA

DC CHARACTERISTICS CURRENTS SINGLE RANK 2Gbit

Symbol	DDR3-800	DDR3-1066	DDR3-1333	DDR3-1600	Unit
IDD0	819	945	1053	1117	mA
IDD1	1008	1125	1224	1293	mA
IDD2P-S	117	117	117	122	mA
IDD2P-F	225	297	315	328	mA
IDD2Q	648	594	675	694	mA
IDD2N	477	603	693	713	mA
IDD3P	288	378	423	438	mA
IDD3N	513	648	747	759	mA
IDD4R	1413	1755	2070	2285	mA
IDD4W	1161	1485	1755	1961	mA
IDD5B	2322	2439	2529	2564	mA
IDD6	108	108	108	108	mA
IDD6ET	108	108	108	108	mA
IDD7	2403	2646	3213	3293	mA

Viking Technology ♦ 2950 Red Hill Ave ♦ Costa Mesa, CA 92626

Office: 714.913.2200 Fax: 714.913.2202 ♦ Website: <http://www.vikingtechnology.com>

This Data Sheet is subject to change without notice.
Doc. # PS7JAxx7258xxx-LF ■ Revision D ■



DC CHARACTERISTICS CURRENTS DUAL RANK 1Gbit

Symbol	DDR3-800	DDR3-1066	DDR3-1333	DDR3-1600	Unit
IDD0	792	900	972	1031	mA
IDD1	972	1107	1197	1265	mA
IDD2P-S	144	144	144	150	mA
IDD2P-F	468	504	540	563	mA
IDD2Q	990	1170	1350	1389	mA
IDD2N	990	1170	1350	1389	mA
IDD3P	540	720	810	838	mA
IDD3N	1170	1350	1530	1554	mA
IDD4R	1332	1602	1962	2166	mA
IDD4W	1512	1872	2142	2394	mA
IDD5B	2420	3600	4140	4197	mA
IDD6	180	180	180	180	mA
IDD6ET	216	216	216	216	mA
IDD7	1962	2322	2772	2841	mA

DC CHARACTERISTICS CURRENTS DUAL RANK 2Gbit

Symbol	DDR3-800	DDR3-1066	DDR3-1333	DDR3-1600	Unit
IDD0	936	1062	1170	1241	mA
IDD1	1125	1242	1341	1417	mA
IDD2P-S	234	234	234	244	mA
IDD2P-F	450	594	630	656	mA
IDD2Q	936	1188	1350	1389	mA
IDD2N	954	1206	1386	1426	mA
IDD3P	576	756	846	876	mA
IDD3N	1026	1296	1494	1518	mA
IDD4R	1530	1872	2187	2414	mA
IDD4W	1278	1602	1872	2092	mA
IDD5B	4644	4878	5058	5128	mA
IDD6	216	216	216	216	mA
IDD6ET	216	216	216	216	mA
IDD7	2520	2763	3330	3413	mA

Viking Technology ♦ 2950 Red Hill Ave ♦ Costa Mesa, CA 92626

Office: 714.913.2200 Fax: 714.913.2202 ♦ Website: <http://www.vikingtechnology.com>

This Data Sheet is subject to change without notice.
Doc. # PS7JAxx7258xxx-LF ■ Revision D ■



DC CHARACTERISTICS CURRENTS SINGLE RANK 4Gbit

Symbol	DDR3-1066	DDR3-1333	DDR3-1600	Unit
IDD0	630	560	611	mA
IDD1	720	810	872	mA
IDD2P-S	216	216	216	mA
IDD2P-F	270	270	270	mA
IDD2Q	450	540	600	mA
IDD2N	450	540	594	mA
IDD3P	270	270	315	mA
IDD3N	540	630	687	mA
IDD4R	945	1125	1390	mA
IDD4W	990	1152	1356	mA
IDD5B	1710	1755	1915	mA
IDD6	216	216	216	mA
IDD6ET	270	270	270	mA
IDD7	1215	1485	1856	mA

DC CHARACTERISTICS CURRENTS DUAL RANK 4Gbit

Symbol	DDR3-1066	DDR3-1333	DDR3-1600	Unit
IDD0	1220	1240	1315	mA
IDD1	1310	1330	1405	mA
IDD2P-S	460	480	500	mA
IDD2P-F	460	480	500	mA
IDD2Q	1020	1040	1070	mA
IDD2N	1020	1040	1070	mA
IDD3P	550	570	590	mA
IDD3N	1240	1260	1280	mA
IDD4R	1530	1685	1860	mA
IDD4W	1535	1700	1900	mA
IDD5B	1920	2165	2195	mA
IDD6	280	280	280	mA
IDD6ET	280	280	280	mA
IDD7	2060	2440	2505	mA

Viking Technology ♦ 2950 Red Hill Ave ♦ Costa Mesa, CA 92626

Office: 714.913.2200 Fax: 714.913.2202 ♦ Website: <http://www.vikingtechnology.com>

This Data Sheet is subject to change without notice.
Doc. # PS7JAx7258xxx-LF ■ Revision D ■



DC CHARACTERISTICS CURRENTS SINGLE RANK 8Gbit

Symbol	DDR3-800	DDR3-1066	DDR3-1333	DDR3-1600	DDR3-1866	Unit
IDD0	549	567	585	603	621	mA
IDD1	621	648	675	702	729	mA
IDD2P-S	99	99	99	99	99	mA
IDD2P-F	72	90	108	126	144	mA
IDD2Q	252	270	288	306	324	mA
IDD2N	270	288	306	324	342	mA
IDD3P	270	288	306	324	342	mA
IDD3N	405	423	441	459	477	mA
IDD4R	855	945	1035	1125	1215	mA
IDD4W	855	945	1035	1125	1215	mA
IDD5B	2070	2115	2160	2205	2250	mA
IDD6	216	216	216	216	216	mA
IDD6ET	72	90	108	126	144	mA
IDD7	1440	1530	1620	1710	1800	mA

DC CHARACTERISTICS CURRENTS DUAL RANK 8Gbit

Symbol	DDR3-800	DDR3-1066	DDR3-1333	DDR3-1600	DDR3-1866	Unit
IDD0	790	816	842	868	894	mA
IDD1	894	933	972	1011	1050	mA
IDD2P-S	142	142	142	142	142	mA
IDD2P-F	103	129	155	181	207	mA
IDD2Q	363	388	414	440	466	mA
IDD2N	388	414	440	466	492	mA
IDD3P	388	414	440	466	492	mA
IDD3N	583	609	635	661	687	mA
IDD4R	1231	1361	1491	1620	1750	mA
IDD4W	1231	1361	1491	1620	1750	mA
IDD5B	2982	3046	3111	3176	3241	mA
IDD6	311	311	311	311	311	mA
IDD6ET	103	129	155	181	207	mA
IDD7	2074	2204	2333	2463	2593	mA

Viking Technology ♦ 2950 Red Hill Ave ♦ Costa Mesa, CA 92626

Office: 714.913.2200 Fax: 714.913.2202 ♦ Website: <http://www.vikingtechnology.com>

This Data Sheet is subject to change without notice.
Doc. # PS7JAx7258xxx-LF ■ Revision D ■



REGISTERING CLOCK DRIVER SPECIFICATIONS

SSTE82882 or equivalent

Symbol	Parameter	Pins	Min	Nom	Max	Units
VDD	DC supply voltage	–	1.425	1.5	1.575	V
VREF	DC reference voltage	–	0.49 × VDD	0.5 × VDD	0.51 × VDD	V
VTT	DC termination voltage	–	VREF – 40 mV	VREF	VREF + 40 mV	V
VIH(AC)	AC high-level input voltage	Control, command, address	VREF + 175mV	–	VDD + 0.4	V
VIL(AC)	AC low-level input voltage	Control, command, address	–0.4	–	VREF - 175mV	V
VIH(DC)	DC high-level input voltage	Control, command, address	VREF + 100mV	–	VDD + 0.4	V
VIL(DC)	DC low-level input voltage	Control, command, address	–0.4	–	VREF - 100mV	V
VIH (CMOS)	High-level input voltage	RESET#, MIRROR	0.65 × VDD	–	VDD	V
VIL (CMOS)	Low-level input voltage	RESET#, MIRROR	0	–	0.35 × VDD	V
VIX(AC)	Differential input crosspoint voltage range	CK, CK#, FBIN, FBIN#	0.5 × VDD - 175mV	0.5 × VDD	0.5 × VDD + 175mV	V
VID(AC)	Differential input voltage	CK, CK#	350	–	VDD + TBD	mV
IOH	High-level output current	FBOUT, FBOUT#	–	–	11	mA
IOL	Low-level output current	ERR_OUT#	25	28	TBD	mA

Notes: Timing and switching specifications for the register are critical for proper operation of the DDR3 SDRAM RDIMMs. These are meant to be a subset of the parameters for the specific device used on the module.

Viking Technology ♦ 2950 Red Hill Ave ♦ Costa Mesa, CA 92626

Office: 714.913.2200 Fax: 714.913.2202 ♦ Website: <http://www.vikingtechnology.com>

This Data Sheet is subject to change without notice.

Doc. # PS7JAxx7258xxx-LF ■ Revision D ■



AC CHARACTERISTICS

Refresh parameters by device density

Parameter	Symbol	1Gb	2Gb	4Gb	8Gb	Units	Notes	
REF command to ACT or REF command time	tRFC	110	160	260	350	ns		
Average periodic refresh interval	tREFI	0 °C ≤ TCASE ≤ 85 °C	7.8	7.8	7.8	7.8	µs	
		85 °C < TCASE ≤ 95 °C	3.9	3.9	3.9	3.9	µs	1

Note: 1) Users should refer to the DRAM supplier data sheet and/or the DIMM SPD to determine if DDR3 SDRAM devices support the following options or requirements referred to in this material.

DDR3-800 Speed Bins and Operating Conditions

Speed Bin		DDR3-800		Unit	Notes	
CL-nRCD-nRP		6-6-6				
Parameter	Symbol	min	max			
Internal read command to first data	tAA	15	20	ns		
ACT to internal read or write delay time	tRCD	15	—	ns		
PRE command period	tRP	15	—	ns		
ACT to ACT or REF command period	tRC	52.5	—	ns		
ACT to PRE command period	tRAS	37.5	9 * tREFI	ns		
CL = 6	CWL = 5	tCK(AVG)	2.5	3.3	ns	1, 2, 3
Supported CL Settings		6		nCK	13	
Supported CWL Settings		5		nCK		

DDR3-1066 Speed Bins and Operating Conditions

Speed Bin		DDR3-1066		Unit	Note	
CL-nRCD-nRP		7-7-7				
Parameter	Symbol	min	max			
Internal read command to first data	tAA	13.125	20	ns		
ACT to internal read or write delay time	tRCD	13.125	—	ns		
PRE command period	tRP	13.125	—	ns		
ACT to ACT or REF command period	tRC	50.625	—	ns		
ACT to PRE command period	tRAS	37.5	9 * tREFI	ns		
CL = 6	CWL = 5	tCK(AVG)	2.5	3.3	ns	1,2,3,6,
	CWL = 6	tCK(AVG)	Reserved		ns	1,2,3,4,
CL = 7	CWL = 5	tCK(AVG)	Reserved		ns	4,
	CWL = 6	tCK(AVG)	1.875	< 2.5	ns	1,2,3,4,
CL = 8	CWL = 5	tCK(AVG)	Reserved		ns	4,
	CWL = 6	tCK(AVG)	1.875	< 2.5	ns	1,2,3,
Supported CL Settings		6, 7, 8		nCK	13	
Supported CWL Settings		5, 6		nCK		

Viking Technology ♦ 2950 Red Hill Ave ♦ Costa Mesa, CA 92626

Office: 714.913.2200 Fax: 714.913.2202 ♦ Website: <http://www.vikingtechnology.com>

This Data Sheet is subject to change without notice.
Doc. # PS7JAx7258xxx-LF ■ Revision D ■

DDR3-1333 Speed Bins and Operating Conditions

Speed Bin		DDR3-1333		Unit	Note	
CL-nRCD-nRP		9-9-9				
Parameter	Symbol	min	max			
Internal read command to first data	<i>tAA</i>	13.5 (13.125)5,11	20	ns		
ACT to internal read or write delay time	<i>tRCD</i>	13.5 (13.125)5,11	—	ns		
PRE command period	<i>tRP</i>	13.5 (13.125)5,11	—	ns		
ACT to ACT or REF command period	<i>tRC</i>	49.5 (49.125)5,11	—	ns		
ACT to PRE command period	<i>tRAS</i>	36	9 * tREFI	ns		
CL = 6	CWL = 5	<i>tCK(AVG)</i>	2.5	3.3	ns	1,2,3,7
	CWL = 6	<i>tCK(AVG)</i>	Reserved		ns	1,2,3,4,7
	CWL = 7	<i>tCK(AVG)</i>	Reserved		ns	4
CL = 7	CWL = 5	<i>tCK(AVG)</i>	Reserved		ns	4
	CWL = 6	<i>tCK(AVG)</i>	1.875	< 2.5	ns	1,2,3,4,7
			(Optional)5,11			
CWL = 7	<i>tCK(AVG)</i>	Reserved		ns	1,2,3,4	
CL = 8	CWL = 5	<i>tCK(AVG)</i>	Reserved		ns	4
	CWL = 6	<i>tCK(AVG)</i>	1.875	< 2.5	ns	1,2,3,7
	CWL = 7	<i>tCK(AVG)</i>	Reserved		ns	1,2,3,4
CL = 9	CWL = 5, 6	<i>tCK(AVG)</i>	Reserved		ns	4
	CWL = 7	<i>tCK(AVG)</i>	1.5	<1.875	ns	1,2,3,4
CL = 10	CWL = 5, 6	<i>tCK(AVG)</i>	Reserved		ns	4
			1.5	<1.875	ns	1,2,3
	CWL = 7	<i>tCK(AVG)</i>	(Optional)			
Supported CL Settings		6, 8, (7), 9, (10)		<i>nCK</i>		
Supported CWL Settings		5, 6, 7		<i>nCK</i>		

Viking Technology ♦ 2950 Red Hill Ave ♦ Costa Mesa, CA 92626

Office: 714.913.2200 Fax: 714.913.2202 ♦ Website: <http://www.vikingtechnology.com>

This Data Sheet is subject to change without notice.
Doc. # PS7JAx7258xxx-LF ■ Revision D ■



DDR3-1600 Speed Bins and Operating Conditions

Speed Bin		DDR3-1600		Unit	Note	
CL-nRCD-nRP		11-11-11				
Parameter	Symbol	min	max			
Internal read command to first data	<i>tAA</i>	13.75 (13.125)9	20	ns		
ACT to internal read or write delay time	<i>tRCD</i>	13.75 (13.125)9	—	ns		
PRE command period	<i>tRP</i>	13.75 (13.125)9	—	ns		
ACT to ACT or REF command period	<i>tRC</i>	48.75 (48.125)9	—	ns		
ACT to PRE command period	<i>tRAS</i>	35	9 * tREFI	ns		
CL = 6	CWL = 5	<i>tCK(AVG)</i>	2.5	3.3	ns	1,2,3,7
	CWL = 6	<i>tCK(AVG)</i>	Reserved		ns	1,2,3,4,7
	CWL = 7	<i>tCK(AVG)</i>	Reserved		ns	4
CL = 7	CWL = 5	<i>tCK(AVG)</i>	Reserved		ns	4
	CWL = 6	<i>tCK(AVG)</i>	1.875	< 2.5	ns	1,2,3,4,7
	CWL = 7	<i>tCK(AVG)</i>	(Optional)5,11		ns	1,2,3,4
CL = 8	CWL = 5	<i>tCK(AVG)</i>	Reserved		ns	4
	CWL = 6	<i>tCK(AVG)</i>	1.875	< 2.5	ns	1,2,3,7
	CWL = 7	<i>tCK(AVG)</i>	Reserved		ns	1,2,3,4
CL = 9	CWL = 5, 6	<i>tCK(AVG)</i>	Reserved		ns	4
	CWL = 7	<i>tCK(AVG)</i>	1.5	<1.875	ns	1,2,3,4
CL = 10	CWL = 5, 6	<i>tCK(AVG)</i>	Reserved		ns	4
	CWL = 7	<i>tCK(AVG)</i>	1.5	<1.875	ns	1,2,3
CL = 11	CWL = 5, 6, 7	<i>tCK(AVG)</i>	Reserved		ns	4
	CWL = 8	<i>tCK(AVG)</i>	1.25	<1.5	ns	1,2,3,9
Supported CL Settings		6, 8, 7, 9, 10, 11		<i>nCK</i>		
Supported CWL Settings		5, 6, 7, 8		<i>nCK</i>		

DDR3-1866 Speed Bins and Operating Conditions

Speed Bin		DDR3-1866		Unit	Note	
CL-nRCD-nRP		13-13-13				
Parameter	Symbol	min	max			
Internal read command to first data	<i>tAA</i>	13.91 (13.125)10	20	ns		
ACT to internal read or write delay time	<i>tRCD</i>	13.91 (13.125)10	—	ns		
PRE command period	<i>tRP</i>	13.91 (13.125)10	—	ns		
ACT to ACT or REF command period	<i>tRC</i>	47.91 (47.125)10	—	ns		
ACT to PRE command period	<i>tRAS</i>	34	9 * tREFI	ns		
CL = 6	CWL = 5	<i>tCK(AVG)</i>	2.5	3.3	ns	1,2,3,8
	CWL = 6	<i>tCK(AVG)</i>	Reserved		ns	1,2,3,4,8
	CWL = 7,8,9	<i>tCK(AVG)</i>	Reserved		ns	4
CL = 7	CWL = 5	<i>tCK(AVG)</i>	Reserved		ns	4
	CWL = 6	<i>tCK(AVG)</i>	1.875	2.5	ns	1,2,3,4,8

Viking Technology ♦ 2950 Red Hill Ave ♦ Costa Mesa, CA 92626

Office: 714.913.2200 Fax: 714.913.2202 ♦ Website: <http://www.vikingtechnology.com>

This Data Sheet is subject to change without notice.
Doc. # PS7JAx7258xxx-LF ■ Revision D ■



Speed Bin		DDR3-1866		Unit	Note
CL-nRCD-nRP		13-13-13			
Parameter	Symbol	min	max		
	CWL = 7,8,9	<i>tCK(AVG)</i>	Reserved	ns	4
CL = 8	CWL = 5	<i>tCK(AVG)</i>	Reserved	ns	4
	CWL = 6	<i>tCK(AVG)</i>	1.875	< 2.5	1,2,3,8
	CWL = 7	<i>tCK(AVG)</i>	Reserved	ns	1,2,3,4,8
	CWL = 8,9	<i>tCK(AVG)</i>	Reserved		4
CL = 9	CWL = 5, 6	<i>tCK(AVG)</i>	Reserved	ns	4
	CWL = 7	<i>tCK(AVG)</i>	1.5	1.875	1,2,3,4,8
	CWL = 8	<i>tCK(AVG)</i>	Reserved	ns	4
	CWL = 9	<i>tCK(AVG)</i>	Reserved	ns	4
CL = 10	CWL = 5, 6	<i>tCK(AVG)</i>	Reserved	ns	4
	CWL = 7	<i>tCK(AVG)</i>	1.5	<1.875	1,2,3,8
	CWL = 8	<i>tCK(AVG)</i>	Reserved	ns	1,2,3,4,8
CL = 11	CWL = 5, 6, 7	<i>tCK(AVG)</i>	Reserved	ns	4
	CWL = 8	<i>tCK(AVG)</i>	1.25	1.5	1,2,3,9
	CWL = 9	<i>tCK(AVG)</i>	Reserved	ns	4
CL = 12	CWL = 5, 6,7,8	<i>tCK(AVG)</i>	Reserved	ns	4
	CWL = 9	<i>tCK(AVG)</i>	Reserved	ns	1,2,3,4
CL = 13	CWL = 5, 6,7,8	<i>tCK(AVG)</i>	Reserved	ns	4
	CWL = 9	<i>tCK(AVG)</i>	1.071	<1.25	1,2,3,9
Supported CL Settings		6, 7, 8, 9, 10, 11,13		<i>nCK</i>	
Supported CWL Settings		5, 6, 7, 8,9		<i>nCK</i>	

Viking Technology ♦ 2950 Red Hill Ave ♦ Costa Mesa, CA 92626

Office: 714.913.2200 Fax: 714.913.2202 ♦ Website: <http://www.vikingtechnology.com>

This Data Sheet is subject to change without notice.
Doc. # PS7JAx7258xxx-LF ■ Revision D ■



Speed Bin Table Notes

1. Absolute Specification (TOPER; VDDQ = VDD = 1.5V +/- 0.075 V);
2. The CL setting and CWL setting result in tCK(AVG).MIN and tCK(AVG).MAX requirements. When making a selection of tCK(AVG), both need to be fulfilled: Requirements from CL setting as well as requirements from CWL setting.
3. tCK(AVG).MIN limits: Since CAS Latency is not purely analog - data and strobe output are synchronized by the DLL - all possible intermediate frequencies may not be guaranteed. An application should use the next smaller JEDEC standard tCK(AVG) value (3.0, 2.5, 1.875, 1.5, 1.25, 1.07, or 0.935 ns) when calculating CL [nCK] = tAA [ns] / tCK(AVG) [ns], rounding up to the next 'Supported CL', where tCK(AVG) = 3.0 ns should only be used for CL = 5 calculation.
4. tCK(AVG).MAX limits: Calculate tCK(AVG) = tAA.MAX / CL SELECTED and round the resulting tCK(AVG) down to the next valid speed bin (i.e. 3.3ns or 2.5ns or 1.875 ns or 1.5 ns or 1.25 ns or 1.07 ns or 0.935 ns). This result is tCK(AVG).MAX corresponding to CL SELECTED.
5. 'Reserved' settings are not allowed. User must program a different value.
6. 'Optional' settings allow certain devices in the industry to support this setting; however, it is not a mandatory feature. Refer to supplier's data sheet and/or the DIMM SPD information if and how this setting is supported.
7. Any DDR3-1066 speed bin also supports functional operation at lower frequencies as shown in the table which are not subject to Production Tests but verified by Design/Characterization.
8. Any DDR3-1333 speed bin also supports functional operation at lower frequencies as shown in the table which are not subject to Production Tests but verified by Design/Characterization.
9. Any DDR3-1600 speed bin also supports functional operation at lower frequencies as shown in the table which are not subject to Production Tests but verified by Design/Characterization.
10. For devices supporting optional down binning to CL=7 and CL=9, tAA/tRCD/tRPmin must be 13.125 ns or lower. SPD settings must be programmed to match. For example, DDR3-1333H devices supporting down binning to DDR3-1066F should program 13.125 ns in SPD bytes for tAAmin (Byte 16), tRCDmin (Byte 18), and tRPmin (Byte 20). DDR3-1600K devices supporting down binning to DDR3-1333H or DDR3-1066F should program 13.125 ns in SPD bytes for tAAmin (Byte16), tRCDmin (Byte 18), and tRPmin (Byte 20). Once tRP (Byte 20) is programmed to 13.125ns, tRCmin (Byte 21, 23) also should be programmed accordingly. For example, 49.125ns (tRASmin + tRPmin = 36 ns + 13.125 ns) for DDR3-1333H and 48.125ns (tRASmin + tRPmin = 35 ns + 13.125 ns) for DDR3-1600K.

Viking Technology ♦ 2950 Red Hill Ave ♦ Costa Mesa, CA 92626

Office: 714.913.2200 Fax: 714.913.2202 ♦ Website: <http://www.vikingtechnology.com>

This Data Sheet is subject to change without notice.

Doc. # PS7JAx7258xxx-LF ■ Revision D ■



Timing Parameters

Parameter	Symbol	DDR3-800		DDR3-1066		DDR3-1333		Units	Note
		MIN	MAX	MIN	MAX	MIN	MAX		
Clock Timing									
Minimum Clock Cycle Time (DLL off mode)	tCK(DLL_OF F)	8	-	8	-	8	-	ns	6
Average Clock Period	tCK(avg)	See Speed Bins Table						ps	
Clock Period	tCK(abs)	tCK(avg)min + tJIT(per)min	tCK(avg)max + tJIT(per)max	tCK(avg)min + tJIT(per)min	tCK(avg)max + tJIT(per)max	tCK(avg)min + tJIT(per)min	tCK(avg)max + tJIT(per)max	ps	
Average high pulse width	tCH(avg)	0.47	0.53	0.47	0.53	0.47	0.53	tCK(avg)	
Average low pulse width	tCL(avg)	0.47	0.53	0.47	0.53	0.47	0.53	tCK(avg)	
Clock Period Jitter	tJIT(per)	-100	100	-90	90	-80	80	ps	
Clock Period Jitter during DLL locking period	tJIT(per, lck)	-90	90	-80	80	-70	70	ps	
Cycle to Cycle Period Jitter	tJIT(cc)	200		180		160		ps	
Cycle to Cycle Period Jitter during DLL locking period	tJIT(cc, lck)	180		160		140		ps	
Cumulative error across 2 cycles	tERR(2per)	- 147	147	- 132	132	- 118	118	ps	
Cumulative error across 3 cycles	tERR(3per)	- 175	175	- 157	157	- 140	140	ps	
Cumulative error across 4 cycles	tERR(4per)	- 194	194	- 175	175	- 155	155	ps	
Cumulative error across 5 cycles	tERR(5per)	- 209	209	- 188	188	- 168	168	ps	
Cumulative error across 6 cycles	tERR(6per)	- 222	222	- 200	200	- 177	177	ps	
Cumulative error across 7 cycles	tERR(7per)	- 232	232	- 209	209	- 186	186	ps	
Cumulative error across 8 cycles	tERR(8per)	- 241	241	- 217	217	- 193	193	ps	
Cumulative error across 9 cycles	tERR(9per)	- 249	249	- 224	224	- 200	200	ps	
Cumulative error across 10 cycles	tERR(10per)	- 257	257	- 231	231	- 205	205	ps	
Cumulative error across 11 cycles	tERR(11per)	- 263	263	- 237	237	- 210	210	ps	
Cumulative error across 12 cycles	tERR(12per)	- 269	269	- 242	242	- 215	215	ps	
Cumulative error across n = 13, 14 ... 49, 50 cycles	tERR(nper)	tERR(nper)min = (1 + 0.68ln(n))*tJIT(per)min tERR(nper)max = (1 + 0.68ln(n))*tJIT(per)max						ps	24
Absolute clock HIGH pulse width	tCH(abs)	0.43	-	0.43	-	0.43	-	tCK(avg)	25
Absolute clock Low pulse width	tCL(abs)	0.43	-	0.43	-	0.43	-	tCK(avg)	26
Data Timing									
DQS, DQS to DQ skew, per group, per access	tDQSQ	-	200	-	150	-	125	ps	13
DQ output hold time from DQS, DQS	tQH	0.38	-	0.38	-	0.38	-	tCK(avg)	13, g
DQ low-impedance time from CK, CK	tLZ(DQ)	-800	400	-600	300	-500	250	ps	13,14, f
DQ high-impedance time from CK, CK	tHZ(DQ)	-	400	-	300	-	250	ps	13,14, f
Data setup time to DQS, DQS referenced to VIH(AC)VIL(AC) levels	tDS(base)	75	-	25	-	30	-	ps	d, 17
Data hold time to DQS, DQS referenced to VIH(AC)VIL(AC) levels	tDH(base)	150	-	100	-	65	-	ps	d, 17
DQ and DM Input pulse width for each input	tDIPW	600	-	490	-	400	-	ps	28
Data Strobe Timing									
DQS, DQS READ Preamble	tRPRE	0.9	Note 19	0.9	Note 19	0.9	Note 19	tCK	13, 19, g
DQS, DQS differential READ Postamble	tRPST	0.3	Note 11	0.3	Note 11	0.3	Note 11	tCK	11, 13, b
DQS, DQS output high time	tQSH	0.38	-	0.38	-	0.4	-	tCK(avg)	13, g
DQS, DQS output low time	tQSL	0.38	-	0.38	-	0.4	-	tCK(avg)	13, g
DQS, DQS WRITE Preamble	tWPRE	0.9	-	0.9	-	0.9	-	tCK	
DQS, DQS WRITE Postamble	tWPST	0.3	-	0.3	-	0.3	-	tCK	
DQS, DQS rising edge output access time from rising CK, CK	tDQSCK	-400	400	-300	300	-255	255	ps	13, f
DQS, DQS low-impedance time (Referenced from RL-1)	tLZ(DQS)	-800	400	-600	300	-500	250	ps	13,14, f
DQS, DQS high-impedance time (Referenced from RL+BL/2)	tHZ(DQS)	-	400	-	300	-	250	ps	12,13,14
DQS, DQS differential input low pulse width	tDQSL	0.45	0.55	0.45	0.55	0.45	0.55	tCK	29, 31
DQS, DQS differential input high pulse width	tDQSH	0.45	0.55	0.45	0.55	0.45	0.55	tCK	30, 31
DQS, DQS rising edge to CK, CK rising edge	tDQSS	-0.25	0.25	-0.25	0.25	-0.25	0.25	tCK(avg)	c
DQS, DQS falling edge setup time to CK, CK rising edge	tDSS	0.2	-	0.2	-	0.2	-	tCK(avg)	c, 32
DQS, DQS falling edge hold time to CK, CK rising edge	tDSH	0.2	-	0.2	-	0.2	-	tCK(avg)	c, 32

Viking Technology ♦ 2950 Red Hill Ave ♦ Costa Mesa, CA 92626

Office: 714.913.2200 Fax: 714.913.2202 ♦ Website: <http://www.vikingtechnology.com>

This Data Sheet is subject to change without notice.
Doc. # PS7JAx7258xxx-LF ■ Revision D ■



Timing Parameters (Cont.)

Speed Parameter	Symbol	DDR3-800		DDR3-1066		DDR3-1333		Units	Note	
		MIN	MAX	MIN	MAX	MIN	MAX			
Command and Address Timing										
DLL locking time	tDLLK	512	-	512	-	512	-	nCK		
internal READ Command to PRECHARGE Command delay	tRTP	max (4nCK,7.5ns)	-	max (4nCK,7.5ns)	-	max (4nCK,7.5ns)	-		e	
Delay from start of internal write transaction to internal read command	tWTR	max (4nCK,7.5ns)	-	max (4nCK,7.5ns)	-	max (4nCK,7.5ns)	-		e,18	
WRITE recovery time	tWR	15	-	15	-	15	-	ns	e	
Mode Register Set command cycle time	tMRD	4	-	4	-	4	-	nCK		
Mode Register Set command update delay	tMOD	max (12nCK,15ns)	-	max (12nCK,15ns)	-	max (12nCK,15ns)	-			
CAS# to CAS# command delay	tCCD	4	-	4	-	4	-	nCK		
Auto precharge write recovery + precharge time	tDAL(min)	WR + roundup (tRP / tCK(AVG))							nCK	
Multi-Purpose Register Recovery Time	tMPRR	1	-	1	-	1	-	nCK	22	
ACTIVE to PRECHARGE command period	tRAS	See 13.3 " Speed Bins and CL, tRCD, tRP, tRC and tRAS for corresponding Bin" on page 37							ns	e
ACTIVE to ACTIVE command period for 1KB page size	tRRD	max (4nCK,10ns)	-	max (4nCK,7.5ns)	-	max (4nCK,6ns)	-		e	
ACTIVE to ACTIVE command period for 2KB page size	tRRD	max (4nCK,10ns)	-	max (4nCK,10ns)	-	max (4nCK,7.5ns)	-		e	
Four activate window for 1KB page size	tFAW	40	-	37.5	-	30	-	ns	e	
Four activate window for 2KB page size	tFAW	50	-	50	-	45	-	ns	e	
Command and Address setup time to CK, CK referenced to VIH(AC) / VIL(AC) levels	tIS(base)	200	-	125	-	65	-	ps	b,16	
Command and Address hold time from CK, CK referenced to VIH(AC) / VIL(AC) levels	tIH(base)	275	-	200	-	140	-	ps	b,16	
Command and Address setup time to CK, CK referenced to VIH(AC) / VIL(AC) levels	tIS(base) AC150	200 + 150	-	125 + 150	-	65+125	-	ps	b,16,27	
Control & Address Input pulse width for each input	tIPW	900	-	780	-	620	-	ps	28	
Calibration Timing										
Power-up and RESET calibration time	tZQinit	512	-	512	-	512	-	nCK		
Normal operation Full calibration time	tZQoper	256	-	256	-	256	-	nCK		
Normal operation short calibration time	tZQCS	64	-	64	-	64	-	nCK	23	
Reset Timing										
Exit Reset from CKE HIGH to a valid command	tXPR	max(5nCK, tRFC + 10ns)	-	max(5nCK, tRFC + 10ns)	-	max(5nCK, tRFC + 10ns)	-			
Self Refresh Timing										
Exit Self Refresh to commands not requiring a locked DLL	tXS	max(5nCK,tRFC + 10ns)	-	max(5nCK,tRFC + 10ns)	-	max(5nCK,tRFC + 10ns)	-			
Exit Self Refresh to commands requiring a locked DLL	tXSDLL	tDLLK(min)	-	tDLLK(min)	-	tDLLK(min)	-	nCK		
Minimum CKE low width for Self refresh entry to exit timing	tCKESR	tCKE(min) + 1tCK	-	tCKE(min) + 1tCK	-	tCKE(min) + 1tCK	-			
Valid Clock Requirement after Self Refresh Entry (SRE) or Power-Down Entry (PDE)	tCKSRE	max(5nCK, 10ns)	-	max(5nCK, 10ns)	-	max(5nCK, 10ns)	-			
Valid Clock Requirement before Self Refresh Exit (SRX) or Power-Down Exit (PDX) or Reset Exit	tCKSRX	max(5nCK, 10ns)	-	max(5nCK, 10ns)	-	max(5nCK, 10ns)	-			

Viking Technology ♦ 2950 Red Hill Ave ♦ Costa Mesa, CA 92626

Office: 714.913.2200 Fax: 714.913.2202 ♦ Website: <http://www.vikingtechnology.com>

This Data Sheet is subject to change without notice.
Doc. # PS7JAx7258xxx-LF ■ Revision D ■



Timing Parameters(Cont.)

Speed		DDR3-800		DDR3-1066		DDR3-1333		Units	Note
Parameter	Symbol	MIN	MAX	MIN	MAX	MIN	MAX		
Power Down Timing									
Exit Power Down with DLL on to any valid command;Exit Precharge Power Down with DLL frozen to commands not requiring a locked DLL	tXP	max (3nCK, 7.5ns)	-	max (3nCK, 7.5ns)	-	max (3nCK,6ns)	-		
Exit Precharge Power Down with DLL frozen to commands requiring a locked DLL	tXPDLL	max (10nCK, 24ns)	-	max (10nCK, 24ns)	-	max (10nCK, 24ns)	-		2
CKE minimum pulse width	tCKE	max (3nCK, 7.5ns)	-	max (3nCK, 5.625ns)	-	max (3nCK, 5.625ns)	-		
Command pass disable delay	tCPDED	1	-	1	-	1	-	nCK	
Power Down Entry to Exit Timing	tPD	tCKE(min)	9*tREFI	tCKE(min)	9*tREFI	tCKE(min)	9*tREFI	tCK	15
Timing of ACT command to Power Down entry	tACTPDEN	1	-	1	-	1	-	nCK	20
Timing of PRE command to Power Down entry	tPRPDEN	1	-	1	-	1	-	nCK	20
Timing of RD/RDA command to Power Down entry	tRDPDEN	RL + 4 + 1	-	RL + 4 + 1	-	RL + 4 + 1	-		
Timing of WR command to Power Down entry (BL8OTF, BL8MRS, BL4OTF)	tWRPDEN	WL + 4 +(tWR/ tCK(avg))	-	WL + 4 +(tWR/ tCK(avg))	-	WL + 4 +(tWR/ tCK(avg))	-	nCK	9
Timing of WRA command to Power Down entry (BL8OTF, BL8MRS, BL4OTF)	tWRAPDEN	WL + 4 +WR + 1	-	WL + 4 +WR + 1	-	WL + 4 +WR + 1	-	nCK	10
Timing of WR command to Power Down entry (BL4MRS)	tWRPDEN	WL + 2 +(tWR/ tCK(avg))	-	WL + 2 +(tWR/ tCK(avg))	-	WL + 2 +(tWR/ tCK(avg))	-	nCK	9
Timing of WRA command to Power Down entry (BL4MRS)	tWRAPDEN	WL + 2 +WR + 1	-	WL + 2 +WR + 1	-	WL + 2 +WR + 1	-	nCK	10
Timing of REF command to Power Down entry	tREFPDEN	1	-	1	-	1	-		20,21
Timing of MRS command to Power Down entry	tMRSPDEN	tMOD(min)	-	tMOD(min)	-	tMOD(min)	-		
ODT Timing									
ODT high time without write command or with write command and BC4	ODTH4	4	-	4	-	4	-	nCK	
ODT high time with Write command and BL8	ODTH8	6	-	6	-	6	-	nCK	
Asynchronous RTT turn-on delay (Power-Down with DLL frozen)	tAONPD	2	8.5	2	8.5	2	8.5	ns	
Asynchronous RTT turn-off delay (Power-Down with DLL frozen)	tAOFPD	2	8.5	2	8.5	2	8.5	ns	
ODT turn-on	tAON	-400	400	-300	300	-250	250	ps	7,f
RTT_NOM and RTT_WR turn-off time from ODTLoff reference	tAOF	0.3	0.7	0.3	0.7	0.3	0.7	tCK(avg)	8,f
RTT dynamic change skew	tADC	0.3	0.7	0.3	0.7	0.3	0.7	tCK(avg)	f
Write Leveling Timing									
First DQS pulse rising edge after tDQSS margining mode is programmed	tWLMRD	40	-	40	-	40	-	tCK	3
DQS/DQS delay after tDQSS margining mode is programmed	tWLDQSEN	25	-	25	-	25	-	tCK	3
Setup time for tDQSS latch	tWLS	325	-	245	-	195	-	ps	
Write leveling hold time from rising DQS, DQS crossing to rising CK, CK crossing	tWLH	325	-	245	-	195	-	ps	
Write leveling output delay	tWLO	0	9	0	9	0	9	ns	
Write leveling output error	tWLOE	0	2	0	2	0	2	ns	

Timing Parameters (Cont.)

Speed		DDR3-1600		DDR3-1866		MIN	MAX	Units	Note
Parameter	Symbol	MIN	MAX	MIN	MAX				
Clock Timing									
Minimum Clock Cycle Time (DLL off mode)	tCK(DLL OFF F)	8	-	8	-			ns	6
Average Clock Period	tCK(avg)	See Speed Bins Table						ps	
Clock Period	tCK(abs)	tCK(avg)min + tJIT(per)min	tCK(avg)max + tJIT(per)max	tCK(avg)min + tJIT(per)min	tCK(avg)max + tJIT(per)max			ps	
Average high pulse width	tCH(avg)	0.47	0.53	0.47	0.53			tCK(avg)	
Average low pulse width	tCL(avg)	0.47	0.53	0.47	0.53			tCK(avg)	

Viking Technology ♦ 2950 Red Hill Ave ♦ Costa Mesa, CA 92626

Office: 714.913.2200 Fax: 714.913.2202 ♦ Website: <http://www.vikingtechnology.com>

This Data Sheet is subject to change without notice.
Doc. # PS7JAx7258xxx-LF ■ Revision D ■





**DDR3
ECC ADDRESS PARITY MINI-DIMM
VR7JAx7258xxx**

Speed	Parameter		DDR3-1600		DDR3-1866		Units		Note	
	Symbol	MIN	MAX	MIN	MAX	MIN	MAX			
Clock Timing										
Clock Period Jitter	tJIT(per)	-70	70	-60	60			ps		
Clock Period Jitter during DLL locking period	tJIT(per, lck)	-60	60	-50	50			ps		
Cycle to Cycle Period Jitter	tJIT(cc)	140		120				ps		
Cycle to Cycle Period Jitter during DLL locking period	tJIT(cc, lck)	120		100				ps		
Cumulative error across 2 cycles	tERR(2per)	- 103	103	- 88	88			ps		
Cumulative error across 3 cycles	tERR(3per)	- 122	122	- 105	105			ps		
Cumulative error across 4 cycles	tERR(4per)	- 136	136	- 117	117			ps		
Cumulative error across 5 cycles	tERR(5per)	- 147	147	- 126	126			ps		
Cumulative error across 6 cycles	tERR(6per)	- 155	155	- 133	133			ps		
Cumulative error across 7 cycles	tERR(7per)	- 163	163	- 139	139			ps		
Cumulative error across 8 cycles	tERR(8per)	- 169	169	- 145	145			ps		
Cumulative error across 9 cycles	tERR(9per)	- 175	175	- 150	150			ps		
Cumulative error across 10 cycles	tERR(10per)	- 180	180	- 154	154			ps		
Cumulative error across 11 cycles	tERR(11per)	- 184	184	- 158	158			ps		
Cumulative error across 12 cycles	tERR(12per)	- 188	188	- 161	161			ps		
Cumulative error across n = 13, 14 ... 49, 50 cycles	tERR(nper)	tERR(nper)min = (1 + 0.68ln(n))*tJIT(per)min tERR(nper)max = (1 + 0.68ln(n))*tJIT(per)max							ps	24
Absolute clock HIGH pulse width	tCH(abs)	0.43	-	0.43	-			tCK(avg)	25	
Absolute clock Low pulse width	tCL(abs)	0.43	-	0.43	-			tCK(avg)	26	
Data Timing										
DQS, DQS to DQ skew, per group, per access	tDQSQ	-	100	-	85			ps	13	
DQ output hold time from DQS, DQS	tQH	0.38	-	0.38	-			tCK(avg)	13, g	
DQ low-impedance time from CK, CK	tLZ(DQ)	-450	225	-390	195			ps	13,14, f	
DQ high-impedance time from CK, CK	tHZ(DQ)	-	225	-	195			ps	13,14, f	
Data setup time to DQS, DQS referenced to VIH(AC)VIL(AC) levels	tDS(base)	10	-	-	-			ps	d, 17	
Data hold time to DQS, DQS referenced to VIH(AC)VIL(AC) levels	tDH(base)	-	-	0	-			ps	d, 17	
DQ and DM Input pulse width for each input	tDIPW	360	-	320	-			ps	28	
Data Strobe Timing										
DQS, DQS READ Preamble	tRPRE	0.9	Note 19	0.9	Note 19			tCK	13, 19, g	
DQS, DQS differential READ Postamble	tRPST	0.3	Note 11	0.3	Note 11			tCK	11, 13, b	
DQS, DQS output high time	tQSH	0.4	-	0.4	-			tCK(avg)	13, g	
DQS, DQS output low time	tQSL	0.4	-	0.4	-			tCK(avg)	13, g	
DQS, DQS WRITE Preamble	tWPRE	0.9	-	0.9	-			tCK		
DQS, DQS WRITE Postamble	tWPST	0.3	-	0.3	-			tCK		
DQS, DQS rising edge output access time from rising CK, CK	tDQSCK	-225	225	-195	195			ps	13, f	
DQS, DQS low-impedance time (Referenced from RL-1)	tLZ(DQS)	-450	225	-390	195			ps	13,14, f	
DQS, DQS high-impedance time (Referenced from RL+BL/2)	tHZ(DQS)	-	225	-	195			ps	12,13,14	
DQS, DQS differential input low pulse width	tDQSL	0.45	0.55	0.45	0.55			tCK	29, 31	
DQS, DQS differential input high pulse width	tDQSH	0.45	0.55	0.45	0.55			tCK	30, 31	
DQS, DQS rising edge to CK, CK rising edge	tDQSS	-0.27	0.27	-0.27	0.27			tCK(avg)	c	
DQS, DQS falling edge setup time to CK, CK rising edge	tDSS	0.9	Note 19	0.18	-			tCK(avg)	c, 32	
DQS, DQS falling edge hold time to CK, CK rising edge	tDSH	0.3	Note 11	0.18	-			tCK(avg)	c, 32	

Viking Technology ♦ 2950 Red Hill Ave ♦ Costa Mesa, CA 92626

Office: 714.913.2200 Fax: 714.913.2202 ♦ Website: <http://www.vikingtechnology.com>

This Data Sheet is subject to change without notice.
Doc. # PS7JAx7258xxx-LF ■ Revision D ■



Timing Parameters (Cont.)

Speed		DDR3-1600		DDR3-1866				Units	Note	
Parameter	Symbol	MIN	MAX	MIN	MAX	MIN	MAX			
Command and Address Timing										
DLL locking time	tDLLK	512	-	512	-			nCK		
internal READ Command to PRECHARGE Command delay	tRTP	max (4nCK,7.5ns)	-	max (4nCK,7.5ns)	-				e	
Delay from start of internal write transaction to internal read command	tWTR	max (4nCK,7.5ns)	-	max (4nCK,7.5ns)	-				e,18	
WRITE recovery time	tWR	15	-	15	-			ns	e	
Mode Register Set command cycle time	tMRD	4	-	4	-			nCK		
Mode Register Set command update delay	tMOD	max (12nCK,15ns)	-	max (12nCK,15ns)	-					
CAS# to CAS# command delay	tCCD	4	-	4	-			nCK		
Auto precharge write recovery + precharge time	tDAL(min)	WR + roundup (tRP / tCK(AVG))							nCK	
Multi-Purpose Register Recovery Time	tMPRR	1	-	1	-			nCK	22	
ACTIVE to PRECHARGE command period	tRAS	See " Speed Bins and CL, tRCD, tRP, tRC and tRAS for corresponding Bin"							ns	e
ACTIVE to ACTIVE command period for 1KB page size	tRRD	max (4nCK,6ns)	-	max (4nCK,5ns)	-				e	
ACTIVE to ACTIVE command period for 2KB page size	tRRD	max (4nCK,7.5ns)	-	max (4nCK,6ns)	-				e	
Four activate window for 1KB page size	tFAW	30	-	27	-			ns	e	
Four activate window for 2KB page size	tFAW	40	-	35	-			ns	e	
Command and Address setup time to CK, CK referenced to VIH(AC) / VIL(AC) levels	tIS(base)	170	-	-	-			ps	b,16	
Command and Address hold time from CK, CK referenced to VIH(AC) / VIL(AC) levels	tIH(base)	120	-	100	-			ps	b,16	
Command and Address setup time to CK, CK referenced to VIH(AC) / VIL(AC) levels	tIS(base) AC150	-	-	-	-			ps	b,16,27	
Control & Address Input pulse width for each input	tIPW	560	-	535	-			ps	28	
Calibration Timing										
Power-up and RESET calibration time	tZQinit	512	-	Max(512nCK,640ns)	-			nCK		
Normal operation Full calibration time	tZQoper	256	-	Max(256nCK,320ns)	-			nCK		
Normal operation short calibration time	tZQCS	64	-	Max(64nCK,80ns)	-			nCK	23	
Reset Timing										
Exit Reset from CKE HIGH to a valid command	tXPR	max(5nCK, tRFC + 10ns)	-	max(5nCK, tRFC + 10ns)	-	max(5nCK, tRFC + 10ns)	-			
Self Refresh Timing										
Exit Self Refresh to commands not requiring a locked DLL	tXS	max(5nCK, tRFC + 10ns)	-	max(5nCK, tRFC + 10ns)	-	max(5nCK, tRFC + 10ns)	-			
Exit Self Refresh to commands requiring a locked DLL	tXSDLL	tDLLK(min)	-	tDLLK(min)	-	tDLLK(min)	-	nCK		
Minimum CKE low width for Self refresh entry to exit timing	tCKESR	tCKE(min) + 1tCK	-	tCKE(min) + 1tCK	-	tCKE(min) + 1tCK	-			
Valid Clock Requirement after Self Refresh Entry (SRE) or Power-Down Entry (PDE)	tCKSRE	max(5nCK, 10ns)	-	max(5nCK, 10ns)	-	max(5nCK, 10ns)	-			
Valid Clock Requirement before Self Refresh Exit (SRX) or Power-Down Exit (PDX) or Reset Exit	tCKSRX	max(5nCK, 10ns)	-	max(5nCK, 10ns)	-	max(5nCK, 10ns)	-			

Viking Technology ♦ 2950 Red Hill Ave ♦ Costa Mesa, CA 92626

Office: 714.913.2200 Fax: 714.913.2202 ♦ Website: <http://www.vikingtechnology.com>

This Data Sheet is subject to change without notice.
Doc. # PS7JAx7258xxx-LF ■ Revision D ■



Timing Parameters(Cont.)

Speed		DDR3-1600		DDR3-1866				Units	Note
Parameter	Symbol	MIN	MAX	MIN	MAX	MIN	MAX		
Power Down Timing									
Exit Power Down with DLL on to any valid command;Exit Precharge Power Down with DLL frozen to commands not requiring a locked DLL	tXP	max (3nCK, 6ns)	-	max (3nCK, 6ns)	-				
Exit Precharge Power Down with DLL frozen to commands requiring a locked DLL	tXPDLL	max (10nCK, 24ns)	-	max (10nCK, 24ns)	-				2
CKE minimum pulse width	tCKE	max (3nCK, 5ns)	-	max (3nCK, 5ns)	-				
Command pass disable delay	tCPDED	1	-	1	-			nCK	
Power Down Entry to Exit Timing	tPD	tCKE(min)	9*tREFI	tCKE(min)	9*tREFI			tCK	15
Timing of ACT command to Power Down entry	tACTPDEN	1	-	1	-			nCK	20
Timing of PRE command to Power Down entry	tPRPDEN	1	-	1	-			nCK	20
Timing of RD/RDA command to Power Down entry	tRDPDEN	RL + 4 + 1	-	RL + 4 + 1	-				
Timing of WR command to Power Down entry (BL8OTF, BL8MRS, BL4OTF)	tWRPDEN	WL + 4 +(tWR/ tCK(avg))	-	WL + 4 +(tWR/ tCK(avg))	-			nCK	9
Timing of WRA command to Power Down entry (BL8OTF, BL8MRS, BL4OTF)	tWRAPDEN	WL + 4 +WR + 1	-	WL + 4 +WR + 1	-			nCK	10
Timing of WR command to Power Down entry (BL4MRS)	tWRPDEN	WL + 2 +(tWR/ tCK(avg))	-	WL + 2 +(tWR/ tCK(avg))	-			nCK	9
Timing of WRA command to Power Down entry (BL4MRS)	tWRAPDEN	WL + 2 +WR + 1	-	WL + 2 +WR + 1	-			nCK	10
Timing of REF command to Power Down entry	tREFPDEN	1	-	1	-				20,21
Timing of MRS command to Power Down entry	tMRSPDEN	tMOD(min)	-	tMOD(min)	-				
ODT Timing									
ODT high time without write command or with write command and BC4	ODTH4	4	-	4	-			nCK	
ODT high time with Write command and BL8	ODTH8	6	-	6	-			nCK	
Asynchronous RTT turn-on delay (Power-Down with DLL frozen)	tAONPD	2	8.5	2	8.5			ns	
Asynchronous RTT turn-off delay (Power-Down with DLL frozen)	tAOFPD	2	8.5	2	8.5			ns	
ODT turn-on	tAON	-225	225	-195	195			ps	7,f
RTT_NOM and RTT_WR turn-off time from ODTLoff reference	tAOF	0.3	0.7	0.3	0.7			tCK(avg)	8,f
RTT dynamic change skew	tADC	0.3	0.7	0.3	0.7			tCK(avg)	f
Write Leveling Timing									
First DQS pulse rising edge after tDQSS margining mode is programmed	tWLMRD	40	-	40	-			tCK	3
DQS/DQS delay after tDQSS margining mode is programmed	tWLDQSEN	25	-	25	-			tCK	3
Setup time for tDQSS latch	tWLS	165	-	140	-			ps	
Write leveling hold time from rising DQS, DQS crossing to rising CK, CK crossing	tWLH	165	-	140	-			ps	
Write leveling output delay	tWLO	0	7.5	0	7.5			ns	
Write leveling output error	tWLOE	0	2	0	2			ns	

Viking Technology ♦ 2950 Red Hill Ave ♦ Costa Mesa, CA 92626

Office: 714.913.2200 Fax: 714.913.2202 ♦ Website: <http://www.vikingtechnology.com>

This Data Sheet is subject to change without notice.
Doc. # PS7JAx7258xxx-LF ■ Revision D ■



18.1 Jitter Notes

1. Unit 'tCK(avg)' represents the actual tCK(avg) of the input clock under operation. Unit 'nCK' represents one clock cycle of the input clock, counting the actual clock edges.ex) tMRD = 4 [nCK] means; if one Mode Register Set command is registered at Tm, another Mode Register Set command may be registered at Tm+4, even if (Tm+4 - Tm) is 4 x tCK(avg) + tERR(4per),min.
2. These parameters are measured from a command/address signal (CKE, CS, RAS, CAS, WE, ODT, BA0, A0, A1, etc.) transition edge to its respective clock signal (CK/CK) crossing. The spec values are not affected by the amount of clock jitter applied (i.e. tJIT(per), tJIT(cc), etc.), as the setup and hold are relative to the clock signal crossing that latches the command/address. That is, these parameters should be met whether clock jitter is present or not.
3. These parameters are measured from a data strobe signal (DQS(L/U), DQS(L/U)) crossing to its respective clock signal (CK, CK) crossing. The spec values are not affected by the amount of clock jitter applied (i.e. tJIT(per), tJIT(cc), etc.), as these are relative to the clock signal crossing. That is, these parameters should be met whether clock jitter is present or not.
4. These parameters are measured from a data signal (DM(L/U), DQ(L/U)0, DQ(L/U)1, etc.) transition edge to its respective data strobe signal (DQS(L/U), DQS(L/U)#) crossing. Specific Note e For these parameters, the DDR3 SDRAM device supports $t_nPARAM [nCK] = RU\{ tPARAM [ns] / tCK(avg) [ns] \}$, which is in clock cycles, assuming all input clock jitter specifications are satisfied. For example, the device will support $t_nRP = RU\{tRP / tCK(avg)\}$, which is in clock cycles, if all input clock jitter specifications are met. This means: For DDR3-800 6-6-6, of which tRP = 15ns, the device will support $t_nRP = RU\{tRP / tCK(avg)\} = 6$, as long as the input clock jitter specifications are met, i.e. Precharge command at Tm and Active command at Tm+6 is valid even if (Tm+6 - Tm) is less than 15ns due to input clock jitter.
5. When the device is operated with input clock jitter, this parameter needs to be derated by the actual tERR(mper),act of the input clock, where $2 \leq m \leq 12$. (output deratings are relative to the SDRAM input clock.) For example, if the measured jitter into a DDR3-800 SDRAM has tERR(mper),act,min = - 172 ps and tERR(mper),act,max = + 193 ps, then $tDQSCK,min(derated) = tDQSCK,min - tERR(mper),act,max = - 400 ps - 193 ps = - 593 ps$ and $tDQSCK,max(derated) = tDQSCK,max - tERR(mper),act,min = 400 ps + 172 ps = + 572 ps$. Similarly, tLZ(DQ) for DDR3-800 derates to $tLZ(DQ),min(derated) = 800 ps - 193 ps = - 993 ps$ and $tLZ(DQ),max(derated) = 400 ps + 172 ps = + 572 ps$. (Caution on the min/max usage!) Note that tERR(mper),act,min is the minimum measured value of tERR(nper) where $2 \leq n \leq 12$, and tERR(mper),act,max is the maximum measured value of tERR(nper) where $2 \leq n \leq 12$.
6. When the device is operated with input clock jitter, this parameter needs to be derated by the actual tJIT(per),act of the input clock. (output deratings are relative to the SDRAM input clock.) For example, if the measured jitter into a DDR3-800 SDRAM has tCK(avg),act = 2500 ps, tJIT(per),act,min = - 72 ps and tJIT(per),act,max = + 93 ps, then $tRPRE,min(derated) = tRPRE,min + tJIT(per),act,min = 0.9 \times tCK(avg),act + tJIT(per),act,min = 0.9 \times 2500 ps - 72 ps = + 2178 ps$. Similarly, $tQH,min(derated) = tQH,min + tJIT(per),act,min = 0.38 \times tCK(avg),act + tJIT(per),act,min = 0.38 \times 2500 ps - 72 ps = + 878 ps$. (Caution on the min/max usage!)

Viking Technology ♦ 2950 Red Hill Ave ♦ Costa Mesa, CA 92626

Office: 714.913.2200 Fax: 714.913.2202 ♦ Website: <http://www.vikingtechnology.com>

This Data Sheet is subject to change without notice.

Doc. # PS7JAx7258xxx-LF ■ Revision D ■



18.2 Timing Parameter Notes

1. Actual value dependant upon measurement level definitions which are TBD.
2. Commands requiring a locked DLL are: READ (and RAP) and synchronous ODT commands.
3. The max values are system dependent.
4. WR as programmed in mode register
5. Value must be rounded-up to next higher integer value
6. There is no maximum cycle time limit besides the need to satisfy the refresh interval, tREFI.
7. For definition of RTT turn-on time tAON see "Device Operation"
8. For definition of RTT turn-off time tAOF see "Device Operation".
9. tWR is defined in ns, for calculation of tWRPDEN it is necessary to round up tWR / tCK to the next integer.
10. WR in clock cycles as programmed in MR0
11. The maximum read postamble is bound by tDQSCK(min) plus tQSH(min) on the left side and tHZ(DQS)max on the right side. Device Operation.
12. Output timing deratings are relative to the SDRAM input clock. When the device is operated with input clock jitter, this parameter needs to be derated by TBD
13. Value is valid for RON34
14. Single ended signal parameter.
15. tREFI depends on TOPER
16. tIS(base) and tIH(base) values are for 1V/ns CMD/ADD single-ended slew rate and 2V/ns CK, CK differential slew rate, Note for DQ and DM signals, VREF(DC) = VREFDQ(DC). For input only pins except RESET, VREF(DC)=VREFCA(DC). See "Address/ Command Setup, Hold and Derating"
17. tDS(base) and tDH(base) values are for 1V/ns DQ single-ended slew rate and 2V/ns DQS, DQS differential slew rate. Note for DQ and DM signals, VREF(DC)= VREFDQ(DC). For input only pins except RESET, VREF(DC)=VREFCA(DC). See "Data Setup, Hold and Slew Rate Derating"
18. Start of internal write transaction is defined as follows ;
For BL8 (fixed by MRS and on-the-fly) : Rising clock edge 4 clock cycles after WL.
For BC4 (on-the-fly) : Rising clock edge 4 clock cycles after WL
For BC4 (fixed by MRS) : Rising clock edge 2 clock cycles after WL
19. The maximum read preamble is bound by tLZDQS(min) on the left side and tDQSCK(max) on the right side. See "Device Operation"
20. CKE is allowed to be registered low while operations such as row activation, precharge, autoprecharge or refresh are in progress, but power-down IDD spec will not be applied until finishing those operations.
21. Although CKE is allowed to be registered LOW after a REFRESH command once tREFPDEN(min) is satisfied, there are cases where additional time such as tXPDLL(min) is also required. See "Device Operation".
22. Defined between end of MPR read burst and MRS which reloads MPR or disables MPR function.
23. One ZQCS command can effectively correct a minimum of 0.5 % (ZQCorrection) of RON and RTT impedance error within 64 nCK for all speed bins assuming the maximum sensitivities specified in the 'Output Driver Voltage and Temperature Sensitivity' and 'ODT Voltage and Temperature Sensitivity' tables. The appropriate interval between ZQCS commands can be determined from these tables and other application specific parameters. One method for calculating the interval between ZQCS commands, given the temperature (Tdriftrate) and voltage (Vdriftrate) drift rates that the SDRAM is subject to in the application, is illustrated. The interval could be defined by the following formula:

$$\frac{ZQCorrection}{(TSens \times Tdriftrate) + (VSens \times Vdriftrate)}$$

where TSens = max(dRTTdT, dRONdTM) and VSens = max(dRTTdV, dRONdVM) define the SDRAM temperature and voltage sensitivities.

For example, if TSens = 1.5% /°C, VSens = 0.15% / mV, Tdriftrate = 1°C / sec and Vdriftrate = 15 mV / sec, then the interval between ZQCS commands is calculated as:

$$\frac{0.5}{(1.5 \times 1) + (0.15 \times 15)} = 0.133 \sim 128ms$$

24. n = from 13 cycles to 50 cycles. This row defines 38 parameters.
25. tCH(abs) is the absolute instantaneous clock high pulse width, as measured from one rising edge to the following falling edge.
26. tCL(abs) is the absolute instantaneous clock low pulse width, as measured from one falling edge to the following rising edge.
27. The tIS(base) AC150 specifications are adjusted from the tIS(base) specification by adding an additional 100 ps of derating to accommodate for the lower alternate threshold of 150 mV and another 25 ps to account for the earlier reference point [(175 mv - 150 mV) / 1 V/ns].
28. Pulse width of a input signal is defined as the width between the first crossing of VREF(DC) and the consecutive crossing of VREF(DC)
29. tDQSL describes the instantaneous differential input low pulse width on DQS-DQS, as measured from one falling edge to the next consecutive rising edge.
30. tDQSH describes the instantaneous differential input high pulse width on DQS-DQS, as measured from one rising edge to the next consecutive falling edge.
31. tDQSH, act + tDQSL, act = 1 tCK, act ; with tXYZ, act being the actual measured value of the respective timing parameter in the application.
32. tDSH, act + tDSS, act = 1 tCK, act ; with tXYZ, act being the actual measured value of the respective timing parameter in the application.

Viking Technology ♦ 2950 Red Hill Ave ♦ Costa Mesa, CA 92626

Office: 714.913.2200 Fax: 714.913.2202 ♦ Website: <http://www.vikingtechnology.com>

This Data Sheet is subject to change without notice.
Doc. # PS7JAx7258xxx-LF ■ Revision D ■



REVISION HISTORY

Revision	Release Date	Description of Change	Checked By (Full Name)
X1	May 7, 2008	Preliminary release	Brian Ouellette
X2	July 2, 2008	Update to latest proposed pin out.	Brian Ouellette
X3	July 2, 2008	Correction to 244 pin under features	Brian Ouellette
X4	June 5, 2009	Add 2Gb 2R configurations	Brian Ouellette
A	July 13, 2009	Remove Preliminary watermark	Brian Ouellette
B	August 25, 2009	Add PC3-12800 configurations	Brian Ouellette
B1	January 19, 2010	Add AC tables	Brian Ouellette
B2	October 28, 2010	Correct TDQS, TDQS# pin description	Brian Ouellette
B3	May 31, 2011	Added 8GB PN's and updated IDD table for 4Gbit DRAM.	
B4	November 7, 2011	Added new logo and company name	
B5	February 7, 2012	Removed Preliminary from DDR1600 PN's that use the 1250PCB. Updated theDDR3-1600 IDD tables, Speed Bins, Operating Conditions and timing parameters.	
B6	September 17, 2012	Removed PN with CL8, CL10. Added 1 rank 4gbit based VR7JA127258HB* PN's and IDD table	
B7	November 17, 2012	Updated the 2 rank mechanical drawing to match assembly drawing A001784b	
B8	July 20, 2013	Revised mechanical drawing to show dimension in mm and a nominal thickness with tolerance. Added a missing component to dual rank mechanical drawing	
B9	12-Dec-13	Revised the tRFC for 4Gb from 300ns to 260ns	Chanhee Park
C	September 16, 2015	Add 16GB part numbers and IDD values	
D	July 20, 2017	Revise logo. Change company address	

STATEMENT OF COMPLIANCE

Viking Technology (tm), Sanmina Corporation ("Viking") shall use commercially reasonable efforts to provide components, parts, materials, products and processes to Customer that do not contain: (i) lead, mercury, hexavalent chromium, polybrominated biphenyls (PBB) and polybrominated diphenyl ethers (PBDE) above 0.1% by weight in homogeneous material or (ii) cadmium above 0.01% by weight of homogeneous material, except as provided in any exemption(s) from RoHS requirements (including the most current version of the "Annex" to Directive 2002/95/EC of 27 January, 2003), as codified in the specific laws of the EU member countries. Viking strives to obtain appropriate contractual protections from its suppliers in connection with the RoHS Directives.

All printed circuit boards (PCBs) have a flammability rating of UL94V-0.

Viking Technology ♦ 2950 Red Hill Ave ♦ Costa Mesa, CA 92626

Office: 714.913.2200 Fax: 714.913.2202 ♦ Website: <http://www.vikingtechnology.com>

This Data Sheet is subject to change without notice.
Doc. # PS7JAx7258xxx-LF ■ Revision D ■

