

MODULE CONFIGURATIONS

Viking Part Number	Capacity	Module Configuration	Device Configuration	Device Package	Module Ranks	Performance	CAS Latency
VR7YA567258GBA	2GB	256MX72	256Mx8	FBGA	1	PC3-8500	CL7 (7-7-7)
VR7YA567258GBD	2GB	256MX72	256Mx8	FBGA	1	PC3-10600	CL9 (9-9-9)
VR7YA127258HBA	4GB	512MX72	512Mx8	FBGA	1	PC3-8500	CL7 (7-7-7)
VR7YA127258HBD	4GB	512MX72	512Mx8	FBGA	1	PC3-10600	CL9 (9-9-9)
VR7YA127258GHA	4GB	512MX72	256Mx8	BGA stack	2	PC3-8500	CL7 (7-7-7)
VR7YA127258GHD	4GB	512MX72	256Mx8	BGA stack	2	PC3-10600	CL9 (9-9-9)
VR7YA1G7258HHA	8GB	1GX72	512Mx8	BGA stack	2	PC3-8500	CL7 (7-7-7)
VR7YA1G7258HHD	8GB	1GX72	512Mx8	BGA stack	2	PC3-10600	CL9 (9-9-9)

Note: For part numbers containing an x, contact Viking for the complete PN

Features

- JEDEC standard Power Supply
 - VDD = VDDQ = 1.5V ±0.075V
 - VDDSPD = +3.0V to +3.6V
- 204-pin Registered Dual-In-Line Memory Module with parity bit for address and control bus.
- 8 Internal Banks.
- Programmable CAS Latency: 7, 8, 9
- Programmable CAS Write Latency (CWL).
- Programmable Additive Latency (Posted CAS).
- Fixed burst chop (BC) of 4 and burst length (BL) of 8 via the mode register set (MRS)
- Selectable BC4 or BL8 on-the-fly (OTF)
- On-Die-Termination (ODT) and Dynamic ODT for improved signal integrity.
- Refresh, Self Refresh and Power Down Modes.
- ZQ Calibration for output driver and ODT.
- System Level Timing Calibration Support via Write Leveling and Multi Purpose Register (MPR) Read Pattern.
- Serial Presence Detect with EEPROM.
- On-DIMM Thermal Sensor.
- Asynchronous Reset.
- RoHS Compliant* (see last page)

Nomenclature

Module Standard	SDRAM Standard	Clock
PC3-6400	DDR3-800	400MHz
PC3-8500	DDR3-1066	533MHz
PC3-10600	DDR3-1333	667MHz

Viking Technology ♦ 2950 Red Hill Ave ♦ Costa Mesa, CA 92626

Office: 714.913.2200 Fax: 714.913.2202 ♦ Website: <http://www.vikingtechnology.com>

This Data Sheet is subject to change without notice.
Doc. # PS7YAx7258xxx-LF ■ Revision B■



PIN CONFIGURATIONS (REG)

Pin	Front Side	Pin	Back Side	Pin	Front Side	Pin	Back Side	Pin	Front Side	Pin	Back Side	Pin	Front Side	Pin	Back Side
1	VREFDQ	2	Vss	53	Vss	54	DQ28	105	A1	106	A2	157	DM5	158	Vss
3	Vss	4	DQ4	55	DQ24	56	DQ29	107	A0	108	BA1	159	DQ42	160	DQ46
5	DQ0	6	DQ5	57	DQ25	58	Vss	109	VDD	110	VDD	161	DQ43	162	DQ47
7	DQ1	8	Vss	59	DM3	60	DQS3#	111	CK0	112	Par_In	163	Vss	164	Vss
9	Vss	10	DQS0#	61	Vss	62	DQS3	113	CK0#	114	Err_Out	165	DQ48	166	DQ52
11	DM0	12	DQS0	63	DQ26	64	Vss	115	VDD	116	VDD	167	DQ49	168	DQ53
13	DQ2	14	Vss	65	DQ27	66	DQ30	117	A10/AP	118	S3#	169	Vss	170	Vss
15	DQ3	16	DQ6	67	Vss	68	DQ31	119	BA0	120	S2#	171	DQS6#	172	DM6
17	Vss	18	DQ7	69	CB0	70	Vss	121	WE#	122	RAS#	173	DQS6	174	DQ54
19	DQ8	20	Vss	71	CB1	72	CB4	123	VDD	124	VDD	175	Vss	176	DQ55
21	DQ9	22	DQ12	73	Vss	74	CB5	125	CAS#	126	ODT0	177	DQ50	178	Vss
23	Vss	24	DQ13	75	DQS8#	76	DM8	127	S0#	128	ODT1	179	DQ51	180	DQ60
25	DQS1#	26	Vss	77	DQS8	78	Vss	129	S1#	130	A13	181	Vss	182	DQ61
27	DQS1	28	DM1	79	Vss	80	CB6	131	VDD	132	VDD	183	DQ56	184	Vss
29	Vss	30	RESET#	81	CB2	82	CB7	133	DQ32	134	DQ36	185	DQ57	186	DQS7#
31	DQ10	32	Vss	83	CB3	84	VREFCA	135	DQ33	136	DQ37	187	Vss	188	DQS7
33	DQ11	34	DQ14	85	VDD	86	VDD	137	Vss	138	Vss	189	DM7	190	Vss
35	Vss	36	DQ15	87	CKE0	88	A15	139	DQS4#	140	Dm4	191	DQ58	192	DQ62
37	DQ16	38	Vss	89	CKE1	90	A14	141	DQS4	142	DQ38	193	DQ59	194	DQ63
39	DQ17	40	DQ20	91	BA2	92	A9	143	Vss	144	DQ39	195	Vss	196	Vss
41	Vss	42	DQ21	93	VDD	94	VDD	145	DQ34	146	Vss	197	SA0	198	EVENT#
43	DQS2#	44	DM2	95	A12/BC#	96	A11	147	DQ35	148	DQ44	199	VDDSPD	200	SDA
45	DQS2	46	Vss	97	A8	98	A7	149	Vss	150	DQ45	201	SA1	202	SCL
47	Vss	48	DQ22	99	A5	100	A6	151	DQ40	152	Vss	203	Vtt	204	Vtt
49	DQ18	50	DQ23	101	VDD	102	VDD	153	DQ41	154	DQS5#				
51	DQ19	52	Vss	103	A3	104	A4	155	Vss	156	DQS5				

Viking Technology ♦ 2950 Red Hill Ave ♦ Costa Mesa, CA 92626

Office: 714.913.2200 Fax: 714.913.2202 ♦ Website: <http://www.vikingtechnology.com>

This Data Sheet is subject to change without notice.

Doc. # PS7YAx7258xxx-LF ■ Revision B ■



PIN FUNCTION DESCRIPTION

SYMBOL	TYPE	POLARITY	DESCRIPTION
CK0	IN	Positive Edge	Positive line of the differential pair of system clock inputs that drives input to the on-DIMM Clock Driver.
/CK0	IN	Negative Edge	Negative line of the differential pair of system clock inputs that drives the input to the on-DIMM Clock Driver.
CKE[1:0]	IN	Active High	CKE HIGH activates, and CKE LOW deactivates internal clock signals, and device input buffers and output drivers of the SDRAMs. Taking CKE LOW provides PRECHARGE POWER-DOWN and SELF REFRESH operation (all banks idle), or ACTIVE POWER DOWN (row ACTIVE in any bank)
S[3:0]#	IN	Active Low	Enables the associated SDRAM command decoder when low and disables decoder when high. When decoder is disabled, new commands are ignored and previous operations continue. These input signals also disable all outputs (except CKE and ODT) of the register(s) on the DIMM when both inputs are high. When both S[1:0] are high, all register outputs (except CKE, ODT and Chip select) remain in the previous state. For modules supporting 4 ranks, S[3:2] operate similarly to S[1:0] for a second set of register outputs.
ODT[1:0]	IN	Active High	On-Die Termination control signals
RAS#, CAS#, WE#	IN	Active Low	When sampled at the positive rising edge of the clock, CAS#, RAS#, and WE# define the operation to be executed by the SDRAM.
VREFDQ	Supply		Reference voltage for DQ0-DQ63 and CB0-CB7.
VREFCA	Supply		Reference voltage for A0-A15, BA0-BA2, RAS#, CAS#, WE#, S0#, S1#, CKE0, CKE1, Par_In, ODT0 and ODT1.
BA[2:0]	IN	-	Selects which SDRAM bank of eight is activated. BA0 - BA2 define to which bank an Active, Read, Write or Precharge command is being applied. Bank address also determines mode register is to be accessed during an MRS cycle.
A[15:13, 12/BC, 11, 10/AP, 9:0]	IN	-	Provided the row address for Active commands and the column address and Auto Precharge bit for Read/Write commands to select one location out of the memory array in the respective bank. A10 is sampled during a Precharge command to determine whether the Precharge applies to one bank (A10 LOW) or all banks (A10 HIGH). If only one bank is to be precharged, the bank is selected by BA. A12 is also utilized for BL 4/8 identification for "BL on the fly" during CAS# command. The address inputs also provide the op-code during Mode Register Set commands.
DQ [63:0], CB [7:0]	I/O	-	Data and Check Bit Input/Output pins
VDD, VSS	Supply	-	Power and ground for the DDR SDRAM input buffers and core logic.
DM [8:0]	IN	Active High	Masks write data when high, issued concurrently with input data.
VDD, VSS	Supply		Power and ground for the DDR SDRAM input buffers and core logic.
VTT	Supply		Termination Voltage for Address/Command/Control/Clock nets.
DQS[17:0]	I/O	Positive Edge	Positive line of the differential data strobe for input and output data.
DQS [17:0]#	I/O	Negative Edge	Negative line of the differential data strobe for input and output data.
TDQS[17:9], TDQS[17:9]#	OUT		TDQS, TDQS# is applicable for X8 DRAMs only. When enabled via Mode Register A11=1 in MR1, DRAM will enable the same termination resistance function on TDQS, TDQS# that is applied to DQS, DQS#. When disabled via mode register A11=0 in MR1, DM, TDQS will provide the data mask function and TDQS# is not used. X4/X16 DRAMs must disable the TDQS function via mode register A11=0 in MR1
SA [2:0]	IN	-	These signals are tied at the system planar to either VSS or VDDSPD to configure the serial SPD EEPROM address range.
SDA	I/O	-	This bidirectional pin is used to transfer data into or out of the SPD EEPROM. A resistor must be connected from the SDA bus line to VDDSPD on the system planar to act as a pull-up.
SCL	IN	-	This signal is used to clock data into and out of the SPD EEPROM. A resistor may be connected from the SCL bus time to VDDSPD on the system planar to act as a pullup.

Viking Technology ♦ 2950 Red Hill Ave ♦ Costa Mesa, CA 92626
Office: 714.913.2200 Fax: 714.913.2202 ♦ Website: <http://www.vikingtechnology.com>

 This Data Sheet is subject to change without notice.
 Doc. # PS7YAx7258xxx-LF ■ Revision B ■

PIN FUNCTION DESCRIPTION

SYMBOL	TYPE	POLARITY	DESCRIPTION
EVENT#	OUT (open drain)	Active Low	This signal indicates that a thermal event has been detected in the thermal sensing device. The system should guarantee the electrical level requirement is met for the EVENT pin on TS/SPD part.
VDDSPD	Supply	-	Serial EEPROM positive power supply wired to a separate power pin at the connector which supports from 3.0 Volt to 3.6 Volt (nominal 3.3V) operation.
RESET#	IN		The RESET pin is connected to the RST pin on the register and to the OE pin on the PLL. When low, all register outputs will be driven low and the PLL clocks to the DRAMs and register(s) will be set to low level (the PLL will remain synchronized with the input clock)
Par_In	IN		Parity bit for the Address and Control bus. ("1 ": Odd, "0 ": Even)
Err_Out#	OUT		Parity error found in the Address and Control bus
TEST			Used by memory bus analysis tools (unused (NC) on memory DIMMs)

Viking Technology ♦ 2950 Red Hill Ave ♦ Costa Mesa, CA 92626

Office: 714.913.2200 Fax: 714.913.2202 ♦ Website: <http://www.vikingtechnology.com>

This Data Sheet is subject to change without notice.

Doc. # PS7YAx7258xxx-LF ■ Revision B■



MECHANICAL OUTLINE SINGLE RANK

Dimensions are in inches. Tolerance is +/- 0.005, unless otherwise stated.

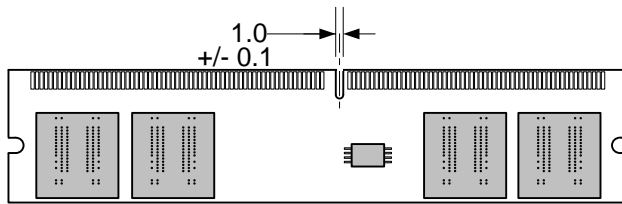
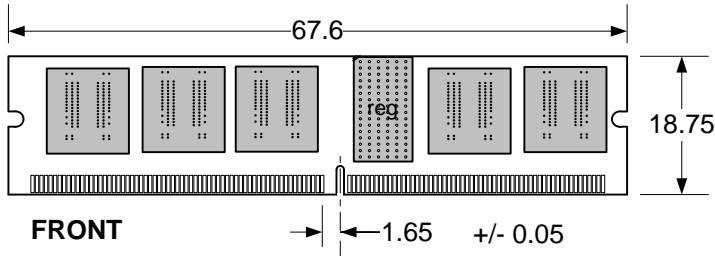

**SIDE VIEW
SINGLE RANK**

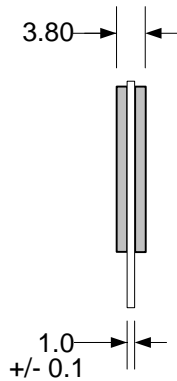

Note: 1) All dimensions in mm. Tolerance: +/- 0.127mm , unless otherwise stated.

Viking Technology ♦ 2950 Red Hill Ave ♦ Costa Mesa, CA 92626

Office: 714.913.2200 Fax: 714.913.2202 ♦ Website: <http://www.vikingtechnology.com>

This Data Sheet is subject to change without notice.

Doc. # PS7YAx7258xxx-LF ■ Revision B ■



MECHANICAL OUTLINE DUAL RANK BGA Stack

Dimensions are in inches. Tolerance is +/- 0.005, unless otherwise stated.

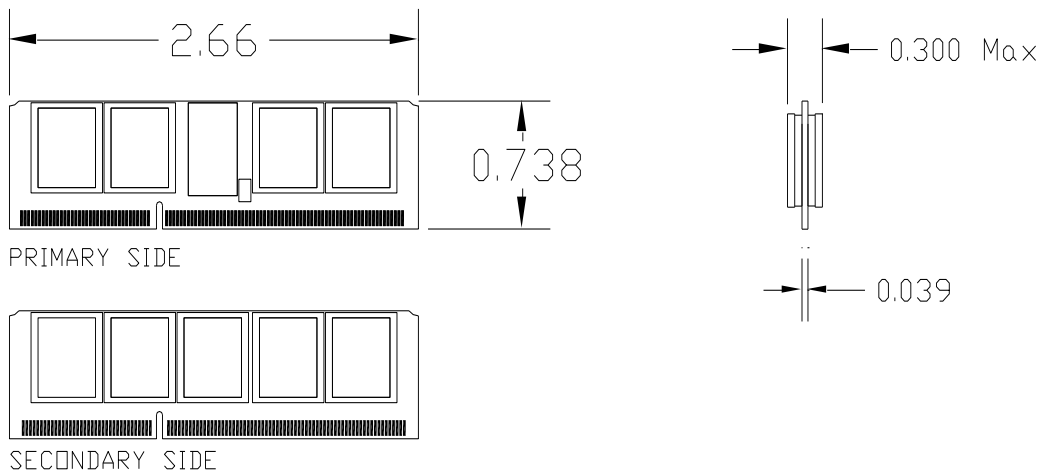

Viking Technology ♦ 2950 Red Hill Ave ♦ Costa Mesa, CA 92626

Office: 714.913.2200 Fax: 714.913.2202 ♦ Website: <http://www.vikingtechnology.com>

This Data Sheet is subject to change without notice.
 Doc. # PS7YAx7258xxx-LF ■ Revision B ■

FUNCTIONAL BLOCK DIAGRAM

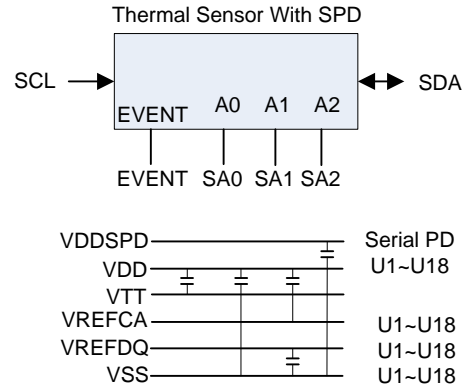
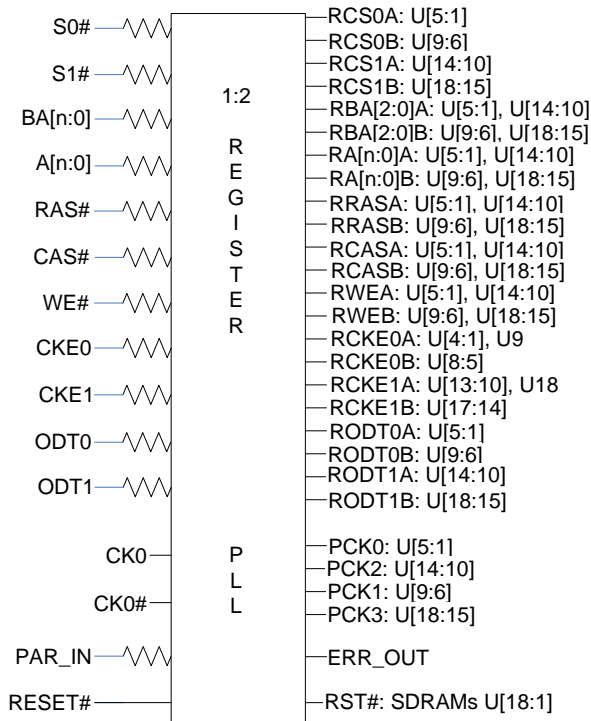

Notes:
The resistor values may vary depending on systems application

FUNCTIONAL BLOCK DIAGRAM

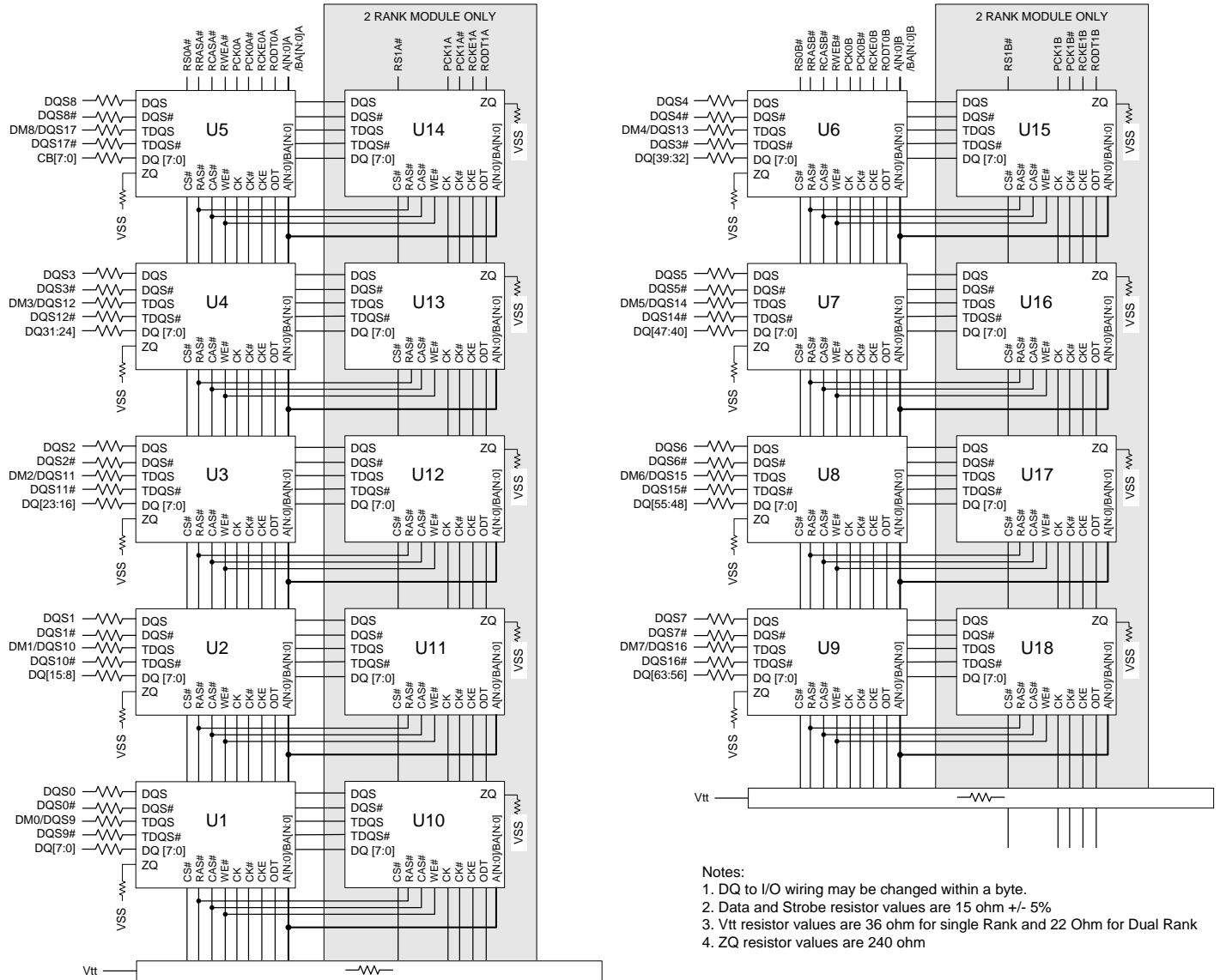

- Notes:
1. DQ to I/O wiring may be changed within a byte.
 2. Data and Strobe resistor values are 15 ohm +/- 5%
 3. Vtt resistor values are 36 ohm for single Rank and 22 Ohm for Dual Rank
 4. ZQ resistor values are 240 ohm

Viking Technology ♦ 2950 Red Hill Ave ♦ Costa Mesa, CA 92626

Office: 714.913.2200 Fax: 714.913.2202 ♦ Website: <http://www.vikingtechnology.com>

This Data Sheet is subject to change without notice.
Doc. # PS7YAx7258xxx-LF ■ Revision B ■



ABSOLUTE MAXIMUM RATINGS

Parameter	Symbol	Value	Unit
Voltage on any pin relative to GND	Vin, Vout	-0.4 ~ 1.975	V
Voltage on VDD supply relative to GND	VDD	-0.4 ~ 1.975	V
Voltage on VDDQ supply relative to GND	VDDQ	-0.4 ~ 1.975	V
Storage temperature	TSTG	-55 ~ +100	°C

Note: Permanent device damage may occur if 'ABSOLUTE MAXIMUM RATINGS' are exceeded. Functional operation should be restricted to recommended operating condition. Exposure to higher than recommended voltage for extended periods of time could affect device reliability.

DC OPERATING CONDITIONS AND CHARACTERISTICS (SSTL_1.5)

Recommended operating conditions (Voltages referenced to GND, Tcase = 0 to 85°C)

Parameter	Symbol	Min.	Max.	Unit	Notes
Case Temperature	Tcase	0	95	°C	5
Supply voltage	VDD	1.425	1.575	V	1, 2
Supply voltage for DQ, DQS	VDDQ	1.425	1.575	V	1, 2
Reference Voltage for DQ, DM inputs	VREFDQ(DC)	0.49 x VDD	0.51 x VDD	V	3, 4
Reference Voltage for ADD, CMD inputs	VREFCA(DC)	0.49 x VDD	0.51 x VDD	V	3, 4
Terminal Voltage	VTT	0.49 x VDD	0.51 x VDD	V	3, 4
EEPROM Supply Voltage	VDDSPD	1.7	3.6	V	
Input high voltage	VIH(AC)	VREF + 0.175	-	V	
	VIH(DC)	VREF + 0.100	VDD		
Input low voltage	VIL(AC)	-	VREF - 0.175	V	
	VIL(DC)	VSS	VREF - 0.100		
Input leakage current	Single Rank	IIL	-5	5	µA
	Dual Rank		-5		
Output leakage current	Single Rank	IOL	-5	5	µA
	Dual Rank		-10		

Note:

- VDDQ tracks with VDD. AC parameters are measured with VDD and VDDQ tied together
- Under all conditions VDDQ must be less than or equal to VDD.
- The ac peak noise on VREF may not allow VREF to deviate from VREF.DC by more than ±1% VDD (for reference: approx. ± 15 mV).
- For reference: approx. VDD/2 ± 15 mV.
- Refresh rate required to be doubled (tREFI = 3.9µs) when 85°C < TC < 95°C.

Viking Technology ♦ 2950 Red Hill Ave ♦ Costa Mesa, CA 92626

Office: 714.913.2200 Fax: 714.913.2202 ♦ Website: <http://www.vikingtechnology.com>

This Data Sheet is subject to change without notice.
Doc. # PS7YAx7258xxx-LF ■ Revision B ■



DEVICE CAPACITANCE

Parameter	Symbol	DDR3-1066		DDR3-1333		Units	Notes
		Min	Max	Min	Max		
Input/output capacitance (DQ, DM, DQS, DQS#, TDQS,TDQS#)	CIO	1.5	2.7	1.5	2.5	pF	1,2,3
Input capacitance, CK and CK#	CCK	0.8	1.6	0.8	1.4	pF	2,3
Input capacitance delta, CK and CK#	CDCK	0	0.15	0	0.15	pF	2,3,4
Input/output capacitance delta DQS and DQS#	CDDQS	0	0.2	0	0.15	pF	2,3,5
Input capacitance, (CTRL, ADD, CMD input-only pins)	CI	0.75	1.35	0.75	1.3	pF	2,3,6
Input/output capacitance of ZQ pin	CZQ	-	3	-	3	pF	2,3,7

- Notes:**
1. Although the DM, TDQS and TDQS# pins have different functions, the loading matches DQ and DQS
 2. This parameter is not subject to production test. It is verified by design and characterization. The capacitance is measured according to JEP147("PROCEDURE FOR MEASURING INPUT CAPACITANCE USING A VECTOR NETWORK ANALYZER(VNA)") with VDD, VDDQ, VSS, VSSQ applied and all other pins floating (except the pin under test, CKE, RESET# and ODT as necessary). VDD=VDDQ=1.5V, VBIAS=VDD/2 and on die termination off.
 3. This parameter applies to monolithic devices only; stacked/dual-die devices are not covered here
 4. Absolute value of CCK-CCK#
 5. Absolute value of CIO(DQS)-CIO(DQS#)
 6. CI applies to ODT, CS#, CKE, A0-A15, BA0-BA2, RAS#, CAS#, WE#.
 7. Maximum external load capacitance on ZQ pin: 5 pF.

Viking Technology ♦ 2950 Red Hill Ave ♦ Costa Mesa, CA 92626

Office: 714.913.2200 Fax: 714.913.2202 ♦ Website: <http://www.vikingtechnology.com>

This Data Sheet is subject to change without notice.
Doc. # PS7YAx7258xxx-LF ■ Revision B■



DC CHARACTERISTICS DEFINITIONS (Recommended operating conditions unless otherwise noted, Tcase = 0 to 85 °C)

Symbol	Conditions	Units	Notes
IDD0	Operating one bank active-precharge current; tCK = tCK(IDD), tRC = tRC(IDD), tRAS = tRASmin(IDD); CKE is HIGH, CS is HIGH between valid commands; Address bus inputs are SWITCHING; Data bus inputs are SWITCHING	mA	1, 2
IDD1	Operating one bank active-read-precharge current; IOUT = 0mA; BL = 8, CL = CL(IDD), AL = 0; tCK = tCK(IDD), tRC = tRC(IDD), tRAS = tRASmin(IDD), tRCD = tRCD(IDD); CKE is HIGH, CS is HIGH between valid commands; Address bus inputs are SWITCHING; Data pattern is same as IDD4W	mA	1, 2
IDD2P-S	Precharge power-down current (slow exit); All banks idle; tCK = tCK(IDD); CKE is LOW; Other control and address bus inputs are STABLE; Data bus inputs are FLOATING	mA	1, 3
IDD2P-F	Precharge power-down current (fast exit); All banks idle; tCK = tCK(IDD); CKE is LOW; Other control and address bus inputs are STABLE; Data bus inputs are FLOATING	mA	1, 3
IDD2Q	Precharge quiet standby current; All banks idle; tCK = tCK(IDD); CKE is HIGH, CS is HIGH; Other control and address bus inputs are STABLE; Data bus inputs are FLOATING	mA	1, 3
IDD2N	Precharge standby current; All banks idle; tCK = tCK(IDD); CKE is HIGH, CS is HIGH; Other control and address bus inputs are SWITCHING; Data bus inputs are SWITCHING	mA	1, 3
IDD3P	Active power-down current; All banks open; tCK = tCK(IDD); CKE is LOW; Other control and address bus inputs are STABLE; Data bus inputs are FLOATING	mA	1, 3
IDD3N	Active standby current; All banks open; tCK = tCK(IDD), tRAS = tRASmax(IDD), tRP = tRP(IDD); CKE is HIGH, CS is HIGH between valid commands; Other control and address bus inputs are SWITCHING; Data bus inputs are SWITCHING	mA	1, 3
IDD4W	Operating burst write current; All banks open, Continuous burst writes; BL = 8, CL = CL(IDD), AL = 0; tCK = tCK(IDD), tRAS = tRASmax(IDD), tRP = tRP(IDD); CKE is HIGH, CS is HIGH between valid commands; Address bus inputs are SWITCHING; Data bus inputs are SWITCHING	mA	1, 2
IDD4R	Operating burst read current; All banks open, Continuous burst reads, IOUT = 0mA; BL = 8, CL = CL(IDD), AL = 0; tCK = tCK(IDD), tRAS = tRASmax(IDD), tRP = tRP(IDD); CKE is HIGH, CS is HIGH between valid commands; Address bus inputs are SWITCHING; Data pattern is same as IDD4W	mA	1, 2
IDD5B	Burst refresh current; tCK = tCK(IDD); Refresh command at every tRFC(IDD) interval; CKE is HIGH, CS is HIGH between valid commands; Other control and address bus inputs are SWITCHING; Data bus inputs are SWITCHING	mA	1, 3
IDD6	Self refresh current; CK and CK at 0V; CKE ≤ 0.2V; Other control and address bus inputs are FLOATING; Data bus inputs are FLOATING	mA	1, 3
IDD6ET	Extended Temperature Range Self-Refresh Current; CK and CK at 0V; CKE ≤ 0.2V; Other control and address inputs are FLOATING; Data Bus inputs are FLOATING, PASR disabled, Applicable for MR2 setting A6=0 and A7=1	mA	1, 3
IDD7	Operating bank interleave read current; All bank interleaving reads, IOUT = 0mA; BL = 8, CL = CL(IDD), AL = tRCD(IDD)-1*tCK(IDD); tCK = tCK(IDD), tRC = tRC(IDD), tRRD = tRRD(IDD), tRCD = 1*tCK(IDD); CKE is HIGH, CS is HIGH between valid commands; Address bus inputs are STABLE during DESELECTs; Data pattern is same as IDD4R;	mA	1, 2

Notes:

1. Calculated values are from component data.
2. One module rank in the active IDD; the other rank in IDD2P-S (slow exit)
3. All ranks in this IDD condition.

Viking Technology ♦ 2950 Red Hill Ave ♦ Costa Mesa, CA 92626

Office: 714.913.2200 Fax: 714.913.2202 ♦ Website: <http://www.vikingtechnology.com>

This Data Sheet is subject to change without notice.

Doc. # PS7YAx7258xxx-LF ■ Revision B ■



DC CHARACTERISTICS CURRENTS SINGLE RANK 2Gbit

Symbol	DDR3-1066	DDR3-1333	Unit
IDD0	315	360	mA
IDD1	405	450	mA
IDD2P-S	108	108	mA
IDD2P-F	135	135	mA
IDD2Q	153	180	mA
IDD2N	153	180	mA
IDD3P	135	135	mA
IDD3N	270	315	mA
IDD4R	585	675	mA
IDD4W	630	720	mA
IDD5B	990	1035	mA
IDD6	108	108	mA
IDD6ET	108	108	mA
IDD7	945	1215	mA

DC CHARACTERISTICS CURRENTS DUAL RANK 2Gbit

Symbol	DDR3-1066	DDR3-1333	Unit
IDD0	630	720	mA
IDD1	810	900	mA
IDD2P-S	216	216	mA
IDD2P-F	270	270	mA
IDD2Q	306	360	mA
IDD2N	306	360	mA
IDD3P	270	270	mA
IDD3N	540	630	mA
IDD4R	1170	1350	mA
IDD4W	1260	1440	mA
IDD5B	1980	2070	mA
IDD6	216	216	mA
IDD6ET	216	216	mA
IDD7	1890	2430	mA

Viking Technology ♦ 2950 Red Hill Ave ♦ Costa Mesa, CA 92626

Office: 714.913.2200 Fax: 714.913.2202 ♦ Website: <http://www.vikingtechnology.com>

This Data Sheet is subject to change without notice.
Doc. # PS7YAx7258xxx-LF ■ Revision B■



DC CHARACTERISTICS CURRENTS SINGLE RANK 4Gbit

Symbol	DDR3-1066	DDR3-1333	Unit
IDD0	630	560	mA
IDD1	720	810	mA
IDD2P-S	216	216	mA
IDD2P-F	270	270	mA
IDD2Q	450	540	mA
IDD2N	450	540	mA
IDD3P	270	270	mA
IDD3N	540	630	mA
IDD4R	945	1125	mA
IDD4W	990	1152	mA
IDD5B	1710	1755	mA
IDD6	216	216	mA
IDD6ET	270	270	mA
IDD7	1215	1485	mA

Viking Technology ♦ 2950 Red Hill Ave ♦ Costa Mesa, CA 92626

Office: 714.913.2200 Fax: 714.913.2202 ♦ Website: <http://www.vikingtechnology.com>

This Data Sheet is subject to change without notice.
 Doc. # PS7YAx7258xxx-LF ■ Revision B■



DC CHARACTERISTICS CURRENTS DUAL RANK 4Gbit

Symbol	DDR3-1066	DDR3-1333	DDR3-1600	Unit
IDD0	1220	1240	1315	mA
IDD1	1310	1330	1405	mA
IDD2P-S	460	480	500	mA
IDD2P-F	460	480	500	mA
IDD2Q	1020	1040	1070	mA
IDD2N	1020	1040	1070	mA
IDD3P	550	570	590	mA
IDD3N	1240	1260	1280	mA
IDD4R	1530	1685	1860	mA
IDD4W	1535	1700	1900	mA
IDD5B	1920	2165	2195	mA
IDD6	280	280	280	mA
IDD6ET	280	280	280	mA
IDD7	2060	2440	2505	mA

Viking Technology ♦ 2950 Red Hill Ave ♦ Costa Mesa, CA 92626

Office: 714.913.2200 Fax: 714.913.2202 ♦ Website: <http://www.vikingtechnology.com>

This Data Sheet is subject to change without notice.

Doc. # PS7YAx7258xxx-LF ■ Revision B■



REGISTERING CLOCK DRIVER SPECIFICATIONS

SSTE82882 or equivalent

Symbol	Parameter	Pins	Min	Nom	Max	Units
VDD	DC supply voltage	–	1.425	1.5	1.575	V
VREF	DC reference voltage	–	0.49 × VDD	0.5 × VDD	0.51 × VDD	V
VTT	DC termination voltage	–	VREF – 40 mV	VREF	VREF + 40 mV	V
VIH(AC)	AC high-level input voltage	Control, command, address	VREF + 175mV	–	VDD + 0.4	V
VIL(AC)	AC low-level input voltage	Control, command, address	–0.4	–	VREF - 175mV	V
VIH(DC)	DC high-level input voltage	Control, command, address	VREF + 100mV	–	VDD + 0.4	V
VIL(DC)	DC low-level input voltage	Control, command, address	–0.4	–	VREF - 100mV	V
VIH (CMOS)	High-level input voltage	RESET#, MIRROR	0.65 × VDD	–	VDD	V
VIL (CMOS)	Low-level input voltage	RESET#, MIRROR	0	–	0.35 × VDD	V
VIX(AC)	Differential input crosspoint voltage range	CK, CK#, FBIN, FBIN#	0.5 × VDD - 175mV	0.5 × VDD	0.5 × VDD + 175mV	V
VID(AC)	Differential input voltage	CK, CK#	350	–	VDD + TBD	mV
IOH	High-level output current	FBOU, FBOU#	–	–	11	mA
IOL	Low-level output current	ERR_OUT#	25	28	TBD	mA

Notes: Timing and switching specifications for the register are critical for proper operation of the DDR3 SDRAM RDIMMs. These are meant to be a subset of the parameters for the specific device used on the module.

Viking Technology ♦ 2950 Red Hill Ave ♦ Costa Mesa, CA 92626

Office: 714.913.2200 Fax: 714.913.2202 ♦ Website: <http://www.vikingtechnology.com>

This Data Sheet is subject to change without notice.
Doc. # PS7YAx7258xxx-LF ■ Revision B■



AC CHARACTERISTICS

Refresh parameters by device density

Parameter	Symbol	1Gb	2Gb	4Gb	8Gb	Units	Notes	
REF command to ACT or REF command time	tRFC	110	160	260	350	ns		
Average periodic refresh interval	tREFI	0 °C ≤ TCASE ≤ 85 °C	7.8	7.8	7.8	7.8	µs	
		85 °C < TCASE ≤ 95 °C	3.9	3.9	3.9	3.9	µs	1

Note: 1) Users should refer to the DRAM supplier data sheet and/or the DIMM SPD to determine if DDR3 SDRAM devices support the following options or requirements referred to in this material.

DDR3-1066 Speed Bins and Operating Conditions

Speed Bin		DDR3-1066		Unit	Note
CL-nRCD-nRP		7-7-7			
Parameter	Symbol	min	max		
Internal read command to first data	tAA	13.125	20	ns	
ACT to internal read or write delay time	tRCD	13.125	—	ns	
PRE command period	tRP	13.125	—	ns	
ACT to ACT or REF command period	tRC	50.625	—	ns	
ACT to PRE command period	tRAS	37.5	9 * tREFI	ns	
CL = 6	CWL = 5	tCK(AVG)	2.5 3.3	ns	1,2,3,6,
	CWL = 6	tCK(AVG)	Reserved	ns	1,2,3,4,
CL = 7	CWL = 5	tCK(AVG)	Reserved	ns	4,
	CWL = 6	tCK(AVG)	1.875 < 2.5	ns	1,2,3,4,
CL = 8	CWL = 5	tCK(AVG)	Reserved	ns	4,
	CWL = 6	tCK(AVG)	1.875 < 2.5	ns	1,2,3,
Supported CL Settings		6, 7, 8		nCK	13
Supported CWL Settings		5, 6		nCK	

Viking Technology ♦ 2950 Red Hill Ave ♦ Costa Mesa, CA 92626

Office: 714.913.2200 Fax: 714.913.2202 ♦ Website: <http://www.vikingtechnology.com>

This Data Sheet is subject to change without notice.

Doc. # PS7YAx7258xxx-LF ■ Revision B ■



DDR3-1333 Speed Bins and Operating Conditions

Speed Bin		DDR3-1333		Unit	Note	
CL-nRCD-nRP		9-9-9				
Parameter	Symbol	min	max			
Internal read command to first data	<i>tAA</i>	13.5 (13.125)5,11	20	ns		
ACT to internal read or write delay time	<i>tRCD</i>	13.5 (13.125)5,11	—	ns		
PRE command period	<i>tRP</i>	13.5 (13.125)5,11	—	ns		
ACT to ACT or REF command period	<i>tRC</i>	49.5 (49.125)5,11	—	ns		
ACT to PRE command period	<i>tRAS</i>	36	9 * tREFI	ns		
CL = 6	CWL = 5	<i>tCK(AVG)</i>	2.5	3.3	ns	1,2,3,7
	CWL = 6	<i>tCK(AVG)</i>	Reserved		ns	1,2,3,4,7
	CWL = 7	<i>tCK(AVG)</i>	Reserved		ns	4
CL = 7	CWL = 5	<i>tCK(AVG)</i>	Reserved		ns	4
	CWL = 6	<i>tCK(AVG)</i>	1.875	< 2.5	ns	1,2,3,4,7
			(Optional)5,11			
CWL = 7	<i>tCK(AVG)</i>	Reserved		ns	1,2,3,4	
CL = 8	CWL = 5	<i>tCK(AVG)</i>	Reserved		ns	4
	CWL = 6	<i>tCK(AVG)</i>	1.875	< 2.5	ns	1,2,3,7
	CWL = 7	<i>tCK(AVG)</i>	Reserved		ns	1,2,3,4
CL = 9	CWL = 5, 6	<i>tCK(AVG)</i>	Reserved		ns	4
	CWL = 7	<i>tCK(AVG)</i>	1.5	<1.875	ns	1,2,3,4
CL = 10	CWL = 5, 6	<i>tCK(AVG)</i>	Reserved		ns	4
			1.5	<1.875	ns	1,2,3
	CWL = 7	<i>tCK(AVG)</i>	(Optional)			
Supported CL Settings		6, 8, (7), 9, (10)		<i>nCK</i>		
Supported CWL Settings		5, 6, 7		<i>nCK</i>		

DDR3-1600 Speed Bins and Operating Conditions

Speed Bin		DDR3-1600		Unit	Note	
CL-nRCD-nRP		11-11-11				
Parameter	Symbol	min	max			
Internal read command to first data	<i>tAA</i>	13.75 (13.125)9	20	ns		
ACT to internal read or write delay time	<i>tRCD</i>	13.75 (13.125)9	—	ns		
PRE command period	<i>tRP</i>	13.75 (13.125)9	—	ns		
ACT to ACT or REF command period	<i>tRC</i>	48.75 (48.125)9	—	ns		
ACT to PRE command period	<i>tRAS</i>	35	9 * tREFI	ns		
CL = 6	CWL = 5	<i>tCK(AVG)</i>	2.5	3.3	ns	1,2,3,7
	CWL = 6	<i>tCK(AVG)</i>	Reserved		ns	1,2,3,4,7
	CWL = 7	<i>tCK(AVG)</i>	Reserved		ns	4
CL = 7	CWL = 5	<i>tCK(AVG)</i>	Reserved		ns	4
	CWL = 6	<i>tCK(AVG)</i>	1.875	< 2.5	ns	1,2,3,4,7
			(Optional)5,11			
CWL = 7	<i>tCK(AVG)</i>	Reserved		ns	1,2,3,4	
CL = 8	CWL = 5	<i>tCK(AVG)</i>	Reserved		ns	4
	CWL = 6	<i>tCK(AVG)</i>	1.875	< 2.5	ns	1,2,3,7

Viking Technology ♦ 2950 Red Hill Ave ♦ Costa Mesa, CA 92626
Office: 714.913.2200 Fax: 714.913.2202 ♦ Website: <http://www.vikingtechnology.com>

 This Data Sheet is subject to change without notice.
 Doc. # PS7YAx7258xxx-LF ■ Revision B ■

Speed Bin		DDR3-1600		Unit	Note	
CL-nRCD-nRP		11-11-11				
Parameter	Symbol	min	max			
CL = 9	CWL = 7	tCK(AVG)	Reserved	ns	1,2,3,4	
	CWL = 5, 6	tCK(AVG)	Reserved	ns	4	
	CWL = 7	tCK(AVG)	1.5	<1.875	ns	1,2,3,4
CL = 10	CWL = 5, 6	tCK(AVG)	Reserved	ns	4	
	CWL = 7	tCK(AVG)	1.5	<1.875	ns	1,2,3
CL = 11	CWL = 5, 6, 7	tCK(AVG)	Reserved	ns	4	
	CWL = 8	tCK(AVG)	1.25	<1.5	ns	1,2,3,9
Supported CL Settings		6, 8, 7, 9, 10, 11		nCK		
Supported CWL Settings		5, 6, 7, 8		nCK		

DDR3-1866 Speed Bins and Operating Conditions

Speed Bin		DDR3-1866		Unit	Note	
CL-nRCD-nRP		13-13-13				
Parameter	Symbol	min	max			
Internal read command to first data	tAA	13.91 (13.125)10	20	ns		
ACT to internal read or write delay time	tRCD	13.91 (13.125)10	—	ns		
PRE command period	tRP	13.91 (13.125)10	—	ns		
ACT to ACT or REF command period	tRC	47.91 (48.125)10	—	ns		
ACT to PRE command period	tRAS	34	9 * tREFI	ns		
CL = 6	CWL = 5	tCK(AVG)	2.5	3.3	ns	1,2,3,8
	CWL = 6	tCK(AVG)	Reserved		ns	1,2,3,4,8
	CWL = 7,8,9	tCK(AVG)	Reserved		ns	4
CL = 7	CWL = 5	tCK(AVG)	Reserved		ns	4
	CWL = 6	tCK(AVG)	1.875	2.5	ns	1,2,3,4,8
	CWL = 7,8,9	tCK(AVG)	(Optional)5,11		ns	1,2,3,4
CL = 8	CWL = 5	tCK(AVG)	Reserved		ns	4
	CWL = 6	tCK(AVG)	1.875	< 2.5	ns	1,2,3,8
	CWL = 7	tCK(AVG)	Reserved		ns	1,2,3,4,8
	CWL = 8,9	tCK(AVG)	Reserved		ns	4
CL = 9	CWL = 5,6	tCK(AVG)	Reserved		ns	4
	CWL = 7	tCK(AVG)	1.5	1.875	ns	1,2,3,4,8
	CWL = 8	tCK(AVG)	Reserved		ns	4
CL = 10	CWL = 9	tCK(AVG)	Reserved		ns	4
	CWL = 5,6,	tCK(AVG)	Reserved		ns	4
	CWL = 7	tCK(AVG)	1.5	<1.875	ns	1,2,3,8
CL = 11	CWL = 8	tCK(AVG)	Reserved		ns	1,2,3,4,8
	CWL = 5,6,7	tCK(AVG)	Reserved		ns	4
	CWL = 8	tCK(AVG)	1.25	1.5	ns	1,2,3,8
	CWL = 9	tCK(AVG)	Reserved		ns	1,2,3,4
CL = 12	CWL = 5, 6, 7,8	tCK(AVG)	Reserved		ns	4
	CWL = 9	tCK(AVG)	1.25	<1.5	ns	1,2,3,4

Viking Technology ♦ 2950 Red Hill Ave ♦ Costa Mesa, CA 92626

Office: 714.913.2200 Fax: 714.913.2202 ♦ Website: <http://www.vikingtechnology.com>

This Data Sheet is subject to change without notice.
Doc. # PS7YAx7258xxx-LF ■ Revision B ■



Speed Bin		DDR3-1866		Unit	Note	
CL-nRCD-nRP		13-13-13				
Parameter		Symbol	min	max		
CL = 13	CWL = 5,6,7,8	tCK(AVG)	Reserved		ns	4
	CWL = 9	tCK(AVG)	1.071	<1.25	ns	1,2,3,9
Supported CL Settings		6, 8, 7, 9, 10, 11,13		nCK		
Supported CWL Settings		5, 6, 7, 8, 9		nCK		

Speed Bin Table Notes

1. Absolute Specification (TOPER; VDDQ = VDD = 1.5V +/- 0.075 V);
2. The CL setting and CWL setting result in tCK(AVG).MIN and tCK(AVG).MAX requirements. When making a selection of tCK(AVG), both need to be fulfilled: Requirements from CL setting as well as requirements from CWL setting.
3. tCK(AVG).MIN limits: Since CAS Latency is not purely analog - data and strobe output are synchronized by the DLL - all possible intermediate frequencies may not be guaranteed. An application should use the next smaller JEDEC standard tCK(AVG) value (3.0, 2.5, 1.875, 1.5, 1.25, 1.07, or 0.935 ns) when calculating CL [nCK] = tAA [ns] / tCK(AVG) [ns], rounding up to the next 'Supported CL', where tCK(AVG) = 3.0 ns should only be used for CL = 5 calculation.
4. tCK(AVG).MAX limits: Calculate tCK(AVG) = tAA.MAX / CL SELECTED and round the resulting tCK(AVG) down to the next valid speed bin (i.e. 3.3ns or 2.5ns or 1.875 ns or 1.5 ns or 1.25 ns or 1.07 ns or 0.935 ns). This result is tCK(AVG).MAX corresponding to CL SELECTED.
5. 'Reserved' settings are not allowed. User must program a different value.
6. 'Optional' settings allow certain devices in the industry to support this setting; however, it is not a mandatory feature. Refer to supplier's data sheet and/or the DIMM SPD information if and how this setting is supported.
7. Any DDR3-1066 speed bin also supports functional operation at lower frequencies as shown in the table which are not subject to Production Tests but verified by Design/Characterization.
8. Any DDR3-1333 speed bin also supports functional operation at lower frequencies as shown in the table which are not subject to Production Tests but verified by Design/Characterization.
9. Any DDR3-1600 speed bin also supports functional operation at lower frequencies as shown in the table which are not subject to Production Tests but verified by Design/Characterization.
10. For devices supporting optional down binning to CL=7 and CL=9, tAA/tRCD/tRPmin must be 13.125 ns or lower. SPD settings must be programmed to match. For example, DDR3-1333H devices supporting down binning to DDR3-1066F should program 13.125 ns in SPD bytes for tAAmin (Byte 16), tRCDmin (Byte 18), and tRPmin (Byte 20). DDR3-1600K devices supporting down binning to DDR3-1333H or DDR3-1066F should program 13.125 ns in SPD bytes for tAAmin (Byte16), tRCDmin (Byte 18), and tRPmin (Byte 20). Once tRP (Byte 20) is programmed to 13.125ns, tRCmin (Byte 21, 23) also should be programmed accordingly. For example, 49.125ns (tRASmin + tRPmin = 36 ns + 13.125 ns) for DDR3-1333H and 48.125ns (tRASmin + tRPmin = 35 ns + 13.125 ns) for DDR3-1600K.

Viking Technology ♦ 2950 Red Hill Ave ♦ Costa Mesa, CA 92626

Office: 714.913.2200 Fax: 714.913.2202 ♦ Website: <http://www.vikingtechnology.com>

This Data Sheet is subject to change without notice.
Doc. # PS7YAx7258xxx-LF ■ Revision B■



Timing Parameters

Parameter	Symbol	DDR3-1066		DDR3-1333		Units	Note
		MIN	MAX	MIN	MAX		
Clock Timing							
Minimum Clock Cycle Time (DLL off mode)	tCK(DLL_OFF)	8	-	8	-	ns	6
Average Clock Period	tCK(avg)	See Speed Bins Table				ps	
Clock Period	tCK(abs)	tCK(avg)min + tJIT(per)min	tCK(avg)max + tJIT(per)max	tCK(avg)min + tJIT(per)min	tCK(avg)max + tJIT(per)max	ps	
Average high pulse width	tCH(avg)	0.47	0.53	0.47	0.53	tCK(avg)	
Average low pulse width	tCL(avg)	0.47	0.53	0.47	0.53	tCK(avg)	
Clock Period Jitter	tJIT(per)	-90	90	-80	80	ps	
Clock Period Jitter during DLL locking period	tJIT(per, lck)	-80	80	-70	70	ps	
Cycle to Cycle Period Jitter	tJIT(cc)	180		160		ps	
Cycle to Cycle Period Jitter during DLL locking period	tJIT(cc, lck)	160		140		ps	
Cumulative error across 2 cycles	tERR(2per)	-132	132	-118	118	ps	
Cumulative error across 3 cycles	tERR(3per)	-157	157	-140	140	ps	
Cumulative error across 4 cycles	tERR(4per)	-175	175	-155	155	ps	
Cumulative error across 5 cycles	tERR(5per)	-188	188	-168	168	ps	
Cumulative error across 6 cycles	tERR(6per)	-200	200	-177	177	ps	
Cumulative error across 7 cycles	tERR(7per)	-209	209	-186	186	ps	
Cumulative error across 8 cycles	tERR(8per)	-217	217	-193	193	ps	
Cumulative error across 9 cycles	tERR(9per)	-224	224	-200	200	ps	
Cumulative error across 10 cycles	tERR(10per)	-231	231	-205	205	ps	
Cumulative error across 11 cycles	tERR(11per)	-237	237	-210	210	ps	
Cumulative error across 12 cycles	tERR(12per)	-242	242	-215	215	ps	
Cumulative error across n = 13, 14 ... 49, 50 cycles	tERR(nper)	tERR(nper)min = (1 + 0.68ln(n))*tJIT(per)min tERR(nper)max = (1 + 0.68ln(n))*tJIT(per)max				ps	24
Absolute clock HIGH pulse width	tCH(abs)	0.43	-	0.43	-	tCK(avg)	25
Absolute clock Low pulse width	tCL(abs)	0.43	-	0.43	-	tCK(avg)	26
Data Timing							
DQS, DQS to DQ skew, per group, per access	tDQSQ	-	150	-	125	ps	13
DQ output hold time from DQS, DQS	tQH	0.38	-	0.38	-	tCK(avg)	13, g
DQ low-impedance time from CK, CK	tLZ(DQ)	-600	300	-500	250	ps	13,14, f
DQ high-impedance time from CK, CK	tHZ(DQ)	-	300	-	250	ps	13,14, f
Data setup time to DQS, DQS referenced to VIH(AC)VIL(AC) levels	tDS(base)	25	-	30	-	ps	d, 17
Data hold time to DQS, DQS referenced to VIH(AC)VIL(AC) levels	tDH(base)	100	-	65	-	ps	d, 17
DQ and DM Input pulse width for each input	tDIPW	490	-	400	-	ps	28
Data Strobe Timing							
DQS, DQS READ Preamble	tRPRE	0.9	Note 19	0.9	Note 19	tCK	13, 19, g
DQS, DQS differential READ Postamble	tRPST	0.3	Note 11	0.3	Note 11	tCK	11, 13, b
DQS, DQS output high time	tQSH	0.38	-	0.4	-	tCK(avg)	13, g
DQS, DQS output low time	tQSL	0.38	-	0.4	-	tCK(avg)	13, g
DQS, DQS WRITE Preamble	tWPRE	0.9	-	0.9	-	tCK	
DQS, DQS WRITE Postamble	tWPST	0.3	-	0.3	-	tCK	
DQS, DQS rising edge output access time from rising CK, CK	tDQSCK	-300	300	-255	255	ps	13,f
DQS, DQS low-impedance time (Referenced from RL-1)	tLZ(DQS)	-600	300	-500	250	ps	13,14,f
DQS, DQS high-impedance time (Referenced from RL+BL/2)	tHZ(DQS)	-	300	-	250	ps	12,13,14
DQS, DQS differential input low pulse width	tDQSL	0.45	0.55	0.45	0.55	tCK	29, 31
DQS, DQS differential input high pulse width	tDQSH	0.45	0.55	0.45	0.55	tCK	30, 31
DQS, DQS rising edge to CK, CK rising edge	tDQSS	-0.25	0.25	-0.25	0.25	tCK(avg)	c
DQS, DQS falling edge setup time to CK, CK rising edge	tDSS	0.2	-	0.2	-	tCK(avg)	c, 32
DQS, DQS falling edge hold time to CK, CK rising edge	tDSH	0.2	-	0.2	-	tCK(avg)	c, 32

Viking Technology ♦ 2950 Red Hill Ave ♦ Costa Mesa, CA 92626

Office: 714.913.2200 Fax: 714.913.2202 ♦ Website: <http://www.vikingtechnology.com>

This Data Sheet is subject to change without notice.
Doc. # PS7YAx7258xxx-LF ■ Revision B ■



Timing Parameters (Cont.)

Speed		DDR3-1066		DDR3-1333		Units	Note	
Parameter	Symbol	MIN	MAX	MIN	MAX			
Command and Address Timing								
DLL locking time	tDLLK	512	-	512	-	nCK		
internal READ Command to PRECHARGE Command delay	tRTP	max (4nCK,7.5ns)	-	max (4nCK,7.5ns)	-		e	
Delay from start of internal write transaction to internal read command	tWTR	max (4nCK,7.5ns)	-	max (4nCK,7.5ns)	-		e,18	
WRITE recovery time	tWR	15	-	15	-	ns	e	
Mode Register Set command cycle time	tMRD	4	-	4	-	nCK		
Mode Register Set command update delay	tMOD	max (12nCK,15ns)	-	max (12nCK,15ns)	-			
CAS# to CAS# command delay	tCCD	4	-	4	-	nCK		
Auto precharge write recovery + precharge time	tDAL(min)	WR + roundup (tRP / tCK(AVG))					nCK	
Multi-Purpose Register Recovery Time	tMPRR	1	-	1	-	nCK	22	
ACTIVE to PRECHARGE command period	tRAS	See " Speed Bins and CL, tRCD, tRP, tRC and tRAS for corresponding Bin"					ns	e
ACTIVE to ACTIVE command period for 1KB page size	tRRD	max (4nCK,7.5ns)	-	max (4nCK,6ns)	-		e	
ACTIVE to ACTIVE command period for 2KB page size	tRRD	max (4nCK,10ns)	-	max (4nCK,7.5ns)	-		e	
Four activate window for 1KB page size	tFAW	37.5	-	30	-	ns	e	
Four activate window for 2KB page size	tFAW	50	-	45	-	ns	e	
Command and Address setup time to CK, CK referenced to VIH(AC) / VIL(AC) levels	tIS(base)	125	-	65	-	ps	b,16	
Command and Address hold time from CK, CK referenced to VIH(AC) / VIL(AC) levels	tIH(base)	200	-	140	-	ps	b,16	
Command and Address setup time to CK, CK referenced to VIH(AC) / VIL(AC) levels	tIS(base) AC150	125 + 150	-	65+125	-	ps	b,16,27	
Control & Address Input pulse width for each input	tIPW	780	-	620	-	ps	28	
Calibration Timing								
Power-up and RESET calibration time	tZQinitl	512	-	512	-	nCK		
Normal operation Full calibration time	tZQoper	256	-	256	-	nCK		
Normal operation short calibration time	tZQCS	64	-	64	-	nCK	23	
Reset Timing								
Exit Reset from CKE HIGH to a valid command	tXPR	max(5nCK, tRFC + 10ns)	-	max(5nCK, tRFC + 10ns)	-			
Self Refresh Timing								
Exit Self Refresh to commands not requiring a locked DLL	tXS	max(5nCK,tRFC + 10ns)	-	max(5nCK,tRFC + 10ns)	-			
Exit Self Refresh to commands requiring a locked DLL	tXSDLL	tDLLK(min)	-	tDLLK(min)	-	nCK		
Minimum CKE low width for Self refresh entry to exit timing	tCKESR	tCKE(min) + 1tCK	-	tCKE(min) + 1tCK	-			
Valid Clock Requirement after Self Refresh Entry (SRE) or Power-Down Entry (PDE)	tCKSRE	max(5nCK, 10ns)	-	max(5nCK, 10ns)	-			
Valid Clock Requirement before Self Refresh Exit (SRX) or Power-Down Exit (PDX) or Reset Exit	tCKSRX	max(5nCK, 10ns)	-	max(5nCK, 10ns)	-			

Viking Technology ♦ 2950 Red Hill Ave ♦ Costa Mesa, CA 92626

Office: 714.913.2200 Fax: 714.913.2202 ♦ Website: <http://www.vikingtechnology.com>

This Data Sheet is subject to change without notice.

Doc. # PS7YAx7258xxx-LF ■ Revision B ■

Timing Parameters(Cont.)

Speed		DDR3-1066		DDR3-1333		Units	Note
Parameter	Symbol	MIN	MAX	MIN	MAX		
Power Down Timing							
Exit Power Down with DLL on to any valid command;Exit Precharge Power Down with DLL frozen to commands not requiring a locked DLL	tXP	max (3nCK, 7.5ns)	-	max (3nCK,6ns)	-		
Exit Precharge Power Down with DLL frozen to commands requiring a locked DLL	tXPDLL	max (10nCK, 24ns)	-	max (10nCK, 24ns)	-		2
CKE minimum pulse width	tCKE	max (3nCK, 5.625ns)	-	max (3nCK, 5.625ns)	-		
Command pass disable delay	tCPDED	1	-	1	-	nCK	
Power Down Entry to Exit Timing	tPD	tCKE(min)	9*tREFI	tCKE(min)	9*tREFI	tCK	15
Timing of ACT command to Power Down entry	tACTPDEN	1	-	1	-	nCK	20
Timing of PRE command to Power Down entry	tPRPDEN	1	-	1	-	nCK	20
Timing of RD/RDA command to Power Down entry	tRDPDEN	RL + 4 + 1	-	RL + 4 + 1	-		
Timing of WR command to Power Down entry (BL8OTF, BL8MRS, BL4OTF)	tWRPDEN	WL + 4 +(tWR/tCK(avg))	-	WL + 4 +(tWR/tCK(avg))	-	nCK	9
Timing of WRA command to Power Down entry (BL8OTF, BL8MRS, BL4OTF)	tWRAPDEN	WL + 4 +WR + 1	-	WL + 4 +WR + 1	-	nCK	10
Timing of WR command to Power Down entry (BL4MRS)	tWRPDEN	WL + 2 +(tWR/tCK(avg))	-	WL + 2 +(tWR/tCK(avg))	-	nCK	9
Timing of WRA command to Power Down entry (BL4MRS)	tWRAPDEN	WL + 2 +WR + 1	-	WL + 2 +WR + 1	-	nCK	10
Timing of REF command to Power Down entry	tREFPDEN	1	-	1	-		20,21
Timing of MRS command to Power Down entry	tMRSPDEN	tMOD(min)	-	tMOD(min)	-		
ODT Timing							
ODT high time without write command or with write command and BC4	ODTH4	4	-	4	-	nCK	
ODT high time with Write command and BL8	ODTH8	6	-	6	-	nCK	
Asynchronous RTT turn-on delay (Power-Down with DLL frozen)	tAONPD	2	8.5	2	8.5	ns	
Asynchronous RTT turn-off delay (Power-Down with DLL frozen)	tAOFPD	2	8.5	2	8.5	ns	
ODT turn-on	tAON	-300	300	-250	250	ps	7,f
RTT_NOM and RTT_WR turn-off time from ODTLoff reference	tAOF	0.3	0.7	0.3	0.7	tCK(avg)	8,f
RTT dynamic change skew	tADC	0.3	0.7	0.3	0.7	tCK(avg)	f
Write Leveling Timing							
First DQS pulse rising edge after tDQSS margining mode is programmed	tWLMRD	40	-	40	-	tCK	3
DQS/DQS delay after tDQS margining mode is programmed	tWLDQSEN	25	-	25	-	tCK	3
Setup time for tDQSS latch	tWLS	245	-	195	-	ps	
Write leveling hold time from rising DQS, DQS crossing to rising CK, CK crossing	tWLH	245	-	195	-	ps	
Write leveling output delay	tWLO	0	9	0	9	ns	
Write leveling output error	tWLOE	0	2	0	2	ns	

Viking Technology ♦ 2950 Red Hill Ave ♦ Costa Mesa, CA 92626

Office: 714.913.2200 Fax: 714.913.2202 ♦ Website: <http://www.vikingtechnology.com>

This Data Sheet is subject to change without notice.

Doc. # PS7YAx7258xxx-LF ■ Revision B ■

18.1 Jitter Notes

1. Unit 'tCK(avg)' represents the actual tCK(avg) of the input clock under operation. Unit 'nCK' represents one clock cycle of the input clock, counting the actual clock edges. ex) tMRD = 4 [nCK] means; if one Mode Register Set command is registered at T_m, another Mode Register Set command may be registered at T_m+4, even if (T_m+4 - T_m) is 4 x tCK(avg) + tERR(4per),min.
2. These parameters are measured from a command/address signal (CKE, CS, RAS, CAS, WE, ODT, BA0, A0, A1, etc.) transition edge to its respective clock signal (CK/CK) crossing. The spec values are not affected by the amount of clock jitter applied (i.e. tJIT(per), tJIT(cc), etc.), as the setup and hold are relative to the clock signal crossing that latches the command/address. That is, these parameters should be met whether clock jitter is present or not.
3. These parameters are measured from a data strobe signal (DQS(L/U), DQS(L/U)) crossing to its respective clock signal (CK, CK) crossing. The spec values are not affected by the amount of clock jitter applied (i.e. tJIT(per), tJIT(cc), etc.), as these are relative to the clock signal crossing. That is, these parameters should be met whether clock jitter is present or not.
4. These parameters are measured from a data signal (DM(L/U), DQ(L/U)0, DQ(L/U)1, etc.) transition edge to its respective data strobe signal (DQS(L/U), DQS(L/U)#) crossing.
5. For these parameters, the DDR3 SDRAM device supports tnPARAM [nCK] = RU{ tPARAM [ns] / tCK(avg) [ns] }, which is in clock cycles, assuming all input clock jitter specifications are satisfied. For example, the device will support tnRP = RU{tRP / tCK(avg)}, which is in clock cycles, if all input clock jitter specifications are met. This means: For DDR3-800 6-6-6, of which tRP = 15ns, the device will support tnRP = RU{tRP / tCK(avg)} = 6, as long as the input clock jitter specifications are met, i.e. Precharge command at T_m and Active command at T_m+6 is valid even if (T_m+6 - T_m) is less than 15ns due to input clock jitter.
6. When the device is operated with input clock jitter, this parameter needs to be derated by the actual tERR(mper),act of the input clock, where 2 <= m <= 12. (output deratings are relative to the SDRAM input clock.) For example, if the measured jitter into a DDR3-800 SDRAM has tERR(mper),act,min = - 172 ps and tERR(mper),act,max = + 193 ps, then tDQSCK,min(derated) = tDQSCK,min - tERR(mper),act,max = - 400 ps - 193 ps = - 593 ps and tDQSCK,max(derated) = tDQSCK,max - tERR(mper),act,min = 400 ps + 172 ps = + 572 ps. Similarly, tLZ(DQ) for DDR3-800 derates to tLZ(DQ),min(derated) = 800 ps - 193 ps = - 993 ps and tLZ(DQ),max(derated) = 400 ps + 172 ps = + 572 ps. (Caution on the min/max usage!) Note that tERR(mper),act,min is the minimum measured value of tERR(nper) where 2 <= n <= 12, and tERR(mper),act,max is the maximum measured value of tERR(nper) where 2 <= n <= 12.
7. When the device is operated with input clock jitter, this parameter needs to be derated by the actual tJIT(per),act of the input clock. (output deratings are relative to the SDRAM input clock.) For example, if the measured jitter into a DDR3-800 SDRAM has tCK(avg),act = 2500 ps, tJIT(per),act,min = - 72 ps and tJIT(per),act,max = + 93 ps, then tRPRE,min(derated) = tRPRE,min + tJIT(per),act,min = 0.9 x tCK(avg),act + tJIT(per),act,min = 0.9 x 2500 ps - 72 ps = + 2178 ps. Similarly, tQH,min(derated) = tQH,min + tJIT(per),act,min = 0.38 x tCK(avg),act + tJIT(per),act,min = 0.38 x 2500 ps - 72 ps = + 878 ps. (Caution on the min/max usage!)= 0.38 x 2500 ps - 72 ps = + 878 ps. (Caution on the min/max usage!)

Viking Technology ♦ 2950 Red Hill Ave ♦ Costa Mesa, CA 92626

Office: 714.913.2200 Fax: 714.913.2202 ♦ Website: <http://www.vikingtechnology.com>

This Data Sheet is subject to change without notice.

Doc. # PS7YAx7258xxx-LF ■ Revision B■



18.2 Timing Parameter Notes

1. Actual value dependant upon measurement level definitions which are TBD.
2. Commands requiring a locked DLL are: READ (and RAP) and synchronous ODT commands.
3. The max values are system dependent.
4. WR as programmed in mode register
5. Value must be rounded-up to next higher integer value
6. There is no maximum cycle time limit besides the need to satisfy the refresh interval, tREFI.
7. For definition of RTT turn-on time tAON see "Device Operation"
8. For definition of RTT turn-off time tAOF see "Device Operation".
9. tWR is defined in ns, for calculation of tWRPDEN it is necessary to round up tWR / tCK to the next integer.
10. WR in clock cycles as programmed in MR0
11. The maximum read postamble is bound by tDQSK(min) plus tQSH(min) on the left side and tHZ(DQS)max on the right side. Device Operation.
12. Output timing deratings are relative to the SDRAM input clock. When the device is operated with input clock jitter, this parameter needs to be derated by TBD
13. Value is valid for RON34
14. Single ended signal parameter.
15. tREFI depends on TOPER
16. tIS(base) and tIH(base) values are for 1V/ns CMD/ADD single-ended slew rate and 2V/ns CK, CK differential slew rate, Note for DQ and DM signals, VREF(DC) = VREFDQ(DC). For input only pins except RESET, VREF(DC)=VREFCA(DC). See "Address/ Command Setup, Hold and Derating"
17. tDS(base) and tDH(base) values are for 1V/ns DQ single-ended slew rate and 2V/ns DQS, DQS differential slew rate. Note for DQ and DM signals, VREF(DC)= VREFDQ(DC). For input only pins except RESET, VREF(DC)=VREFCA(DC). See "Data Setup, Hold and Slew Rate Derating"
18. Start of internal write transaction is defined as follows ;
For BL8 (fixed by MRS and on-the-fly) : Rising clock edge 4 clock cycles after WL.
For BC4 (on-the-fly) : Rising clock edge 4 clock cycles after WL
For BC4 (fixed by MRS) : Rising clock edge 2 clock cycles after WL
19. The maximum read preamble is bound by tLZDQS(min) on the left side and tDQSK(max) on the right side. See "Device Operation"
20. CKE is allowed to be registered low while operations such as row activation, precharge, autoprecharge or refresh are in progress, but power-down IDD spec will not be applied until finishing those operations.
21. Although CKE is allowed to be registered LOW after a REFRESH command once tREFPDEN(min) is satisfied, there are cases where additional time such as tXPDLL(min) is also required. See "Device Operation".
22. Defined between end of MPR read burst and MRS which reloads MPR or disables MPR function.
23. One ZQCS command can effectively correct a minimum of 0.5 % (ZQCorrection) of RON and RTT impedance error within 64 nCK for all speed bins assuming the maximum sensitivities specified in the 'Output Driver Voltage and Temperature Sensitivity' and 'ODT Voltage and Temperature Sensitivity' tables. The appropriate interval between ZQCS commands can be determined from these tables and other application specific parameters. One method for calculating the interval between ZQCS commands, given the temperature (Tdriftrate) and voltage (Vdriftrate) drift rates that the SDRAM is subject to in the application, is illustrated. The interval could be defined by the following formula:

$$\frac{ZQCorrection}{(TSens \times Tdriftrate) + (VSens \times Vdriftrate)}$$

Where TSens = max(dRTTdT, dRONdTM) and VSens = max(dRTTdV, dRONdVM) define the SDRAM temperature and voltage sensitivities.

For example, if TSens = 1.5% /°C, VSens = 0.15% / mV, Tdriftrate = 1°C / sec and Vdriftrate = 15 mV / sec, then the interval between ZQCS commands is calculated as:

$$\frac{0.5}{(1.5 \times 1) + (0.15 \times 15)} = 0.133 \sim 128ms$$

24. n = from 13 cycles to 50 cycles. This row defines 38 parameters.
25. tCH(abs) is the absolute instantaneous clock high pulse width, as measured from one rising edge to the following falling edge.
26. tCL(abs) is the absolute instantaneous clock low pulse width, as measured from one falling edge to the following rising edge.
27. The tIS(base) AC150 specifications are adjusted from the tIS(base) specification by adding an additional 100 ps of derating to accommodate for the lower alternate threshold of 150 mV and another 25 ps to account for the earlier reference point [(175 mv - 150 mV) / 1 V/ns].
28. Pulse width of a input signal is defined as the width between the first crossing of VREF(DC) and the consecutive crossing of VREF(DC)
29. tDQSL describes the instantaneous differential input low pulse width on DQS-DQS, as measured from one falling edge to the next consecutive rising edge.
30. tDQSH describes the instantaneous differential input high pulse width on DQS-DQS, as measured from one rising edge to the next consecutive falling edge.
31. tDQSH, act + tDQSL, act = 1 tCK, act ; with tXYZ, act being the actual measured value of the respective timing parameter in the application.
32. tDSH, act + tDSS, act = 1 tCK, act ; with tXYZ, act being the actual measured value of the respective timing parameter in the application.

Viking Technology ♦ 2950 Red Hill Ave ♦ Costa Mesa, CA 92626

Office: 714.913.2200 Fax: 714.913.2202 ♦ Website: <http://www.vikingtechnology.com>

This Data Sheet is subject to change without notice.

Doc. # PS7YAx7258xxx-LF ■ Revision B■



REVISION HISTORY

Revision	Release Date	Description of Change	Checked By (Full Name)
A	July 19, 2011	Preliminary release	Brian Ouellette
A1	February 19, 2012	Added new company logo and company name Added 8GB PN and IDD table	
A2	September 18, 2012	Added 4GB 1rank PN's and IDD table (based on 1371 PCB)	
A3	June 20, 2013	Revised mechanical drawing to show dimension in mm and a nominal thickness with tolerance. Removed unsupported PN with CAS Latencies 8	
A4	January 2, 2014	Revised the tRFC for 4Gb from 300ns to 260ns	Chanhee Park
B	July 20, 2017	Revise logo. Change company address	

STATEMENT OF COMPLIANCE

Viking Technology, Sanmina Corporation ("Viking") shall use commercially reasonable efforts to provide components, parts, materials, products and processes to Customer that do not contain: (i) lead, mercury, hexavalent chromium, polybrominated biphenyls (PBB) and polybrominated diphenyl ethers (PBDE) above 0.1% by weight in homogeneous material or (ii) cadmium above 0.01% by weight of homogeneous material, except as provided in any exemption(s) from RoHS requirements (including the most current version of the "Annex" to Directive 2002/95/EC of 27 January, 2003), as codified in the specific laws of the EU member countries. Viking strives to obtain appropriate contractual protections from its suppliers in connection with the RoHS Directives.

*SPD programmed in accordance with EDCS-651800

Viking Technology ♦ 2950 Red Hill Ave ♦ Costa Mesa, CA 92626

Office: 714.913.2200 Fax: 714.913.2202 ♦ Website: <http://www.vikingtechnology.com>

This Data Sheet is subject to change without notice.
Doc. # PS7YAx7258xxx-LF ■ Revision B■

